



**RESTORING ISLAND RESILIENCE**

Pacific Regional Invasive Species Management Support Service



**Palmerston Island Administration and Community**



# *R.rattus* and *R.exulans* eradication Operational Plan Palmerston Atoll, 2023



**Author: Em Oyston (Department of Conservation)**

**Date: July 2023**

### Version History

Version	Reason for change	Date
1.4	Updated to reflect new workplan due to logistical changes	12/7/23
1.3	Changes made in response to IEAG feedback	8/6/23
1.2	Sent to IEAG for feedback	21/5/23
1.1	Changes made based on review by SH	15/5/23
1.0	Initial draft	18/4/23



# Contents

<b>Section 1: Project overview and management</b> .....	<b>3</b>
1.1 Introduction and operation overview.....	3
1.2 Companion documents.....	4
1.3 Objectives and targets .....	4
1.4 Project team.....	5
1.5 Key Roles and Responsibilities.....	8
1.6 Timeline and Milestones .....	9
1.7 Project dependencies, risks, and mitigations.....	10
1.8 Consents required .....	11
1.9 Consultation.....	12
1.10 Project debrief and reporting .....	12
<b>Section 2: Site context</b> .....	<b>13</b>
2.1 Location and physical environment.....	13
2.2 Climate.....	15
2.3 Social structure.....	16
2.4 Land use and tenure.....	17
2.5 Existing infrastructure.....	18
2.6 Conservation Values .....	18
2.7 Threats.....	19
<b>Section 3: Operational</b> .....	<b>21</b>
3.1 Overview.....	21
3.2 Community preparation phase (February - July 2023) .....	22
3.3 Phase 1: Grid construction (July 2023).....	25
3.4 Phase 2: Baiting (August 2023) .....	32
3.5 Post-operation monitoring .....	35
<b>Section 4: Logistic details</b> .....	<b>37</b>
4.1 Bait production, transport, and storage .....	37
4.2 Field gear.....	38
1.3 International travel between Rarotonga from New Zealand .....	38
1.4 Accommodation in Rarotonga.....	38
1.5 Transport between Rarotonga and Palmerston Atoll .....	38
1.6 Purchase of food supplies for Palmerston Atoll .....	39
1.7 Accommodation on Palmerston Atoll.....	39
1.8 Communications .....	39
<b>Section 5: Health and Safety</b> .....	<b>40</b>
<b>Section 6: Workplan, task specifications, and equipment list</b> .....	<b>41</b>
6.1 Workplan of phase 1 and 2 project delivery .....	41
6.2 Task specification document links.....	41
6.3 Equipment list .....	43
<b>Appendix 1: Building locations on Home Island</b> .....	<b>44</b>

## Section 1: Project overview and management

### 1.1 Introduction and operation overview

This document covers the operational planning for the eradication of ship rats and kiore from Palmerston Atoll. Kiore are present on two motu (islands) on Palmerston Atoll – Home Island, and Cooks motu; while ship rats are present on Home Island only; thus, the scope of the eradication includes only these two islands for the hand broadcast application of toxic baits. Ensuring rats do not establish on other motus in the Atoll is also critical to the project’s success.

Planning and logistical preparations for the project will take place in New Zealand, Rarotonga, and Palmerston Atoll between February and June 2023. The delivery phase of the eradication expected to take place over a 6-8 week field-period on Palmerston Atoll between August and September 2023.

The operation has several phases as outlined below, and an operation overview is provided in **Table 1.1**:

- Feasibility study (completed January 2023)
- Operational planning (February – June)
- Field delivery – grid construction, bait application, and establishing biosecurity infrastructure (August – September)
- Debrief (September 2023)
- Post operation monitoring and confirmation of outcomes (Summer 2024)

**Table 1.1:** Operation overview

<b>Location</b>	Home Island (36ha) and Cooks Motu (29ha) – two islet groups located in Palmerston Atoll, Cook Islands. Palmerston Atoll is located approximately 500km North-West of Rarotonga.
<b>Target species</b>	<i>Rattus rattus</i> (Home Island only) and <i>Rattus exulans</i> (both Home Island and Cooks Motu)
<b>Timing</b>	Winter 2023 (deployment is July – September 2023)
<b>Outcomes</b>	<ul style="list-style-type: none"> <li>• Rats are eradicated from Palmerston Atoll improving food security and local livelihoods</li> <li>• Eradication of rats removes predation pressures to enable the recovery of the ecosystem and directly benefitting native, endemic, threatened and rare species present.</li> </ul>
<b>Target benefit species</b>	Humans, coconut crabs, green turtles, and range of ground nesting seabirds
<b>Vegetation type</b>	Coconut palms, tropic wooded forests dominated by pandanus and pacific mahogany, exposed coastal vegetation such as <i>Pemphis</i> sp.
<b>Climate</b>	Limited local climate data. Predominant easterly winds, with drier period of the year falling between May and October. Rainfall between July and October is approximately 100mm per month.
<b>Project Manager</b>	Em Oyston (DOC)
<b>Lead organisation</b>	Department of Conservation
<b>Collaborating organisations</b>	Te Ipukarea Society, Palmerston Island Administration and community, National Environment Service, Ministry of Agriculture (all Cook Island organisations)
<b>Methodology</b>	Hand broadcast application Pestoff Rodent Bait 20R® (containing 20ppm brodifacoum) in two separate applications across a 20m x 20m grid, with an additional perimeter application at 20m spacing. 10 day interval between each bait application. Interior and any enclosed roof spaces of buildings baited with open bait trays.
<b>Baiting rates</b>	Home Island - 22.3kg per ha per application Cooks Motu - 35kg per ha per application
<b>Confirmation of success</b>	Baited trail camera monitoring completed in February 2024, in conjunction with community observations.

## 1.2 Companion documents

A key companion document to this operational plan is the [Palmerston Atoll Eradication Planning sheet](#). This sheet is held on the NET teams Microsoft Onedrive to be accessible and editable in low bandwidth scenarios by multiple users.

This planning sheet is a dynamic document and contains the following in respective tabs in allocated worksheets:

- Document register (including task specifications)
- Key contacts
- Overall project timeline
- Task timeline
- Team and role chart
- Progress on community operations
- Fieldwork plan
- Equipment list and tracker
- Vessels and flight itineraries
- First aid kit and controlled drugs register
- Biosecurity/Incursion kit list
- Issue register
- Risk register

The feasibility study document can be found at [DOC-7279208](#).

As part of the rat eradication operation on Palmerston, rodent biosecurity surveillance infrastructure will be established as per this plan. The biosecurity plan for Palmerston Atoll and the Northern Pa Eヌua in the Cook Islands can be found at [DOC-7384168](#).

## 1.3 Objectives and targets

The goal of the project is to eradicate rats from Palmerston Atoll. Result monitoring aims to confirm success by summer 2023/24. **Table 1.3** details specific objectives, outputs, and outcomes for the project.

**Table 1.3: Objectives, outputs, and outcomes for the project**

Area	Objective	Output	Outcome
Biodiversity	<ul style="list-style-type: none"> <li>• Rats are eradicated from Home and Cooks motu</li> </ul>	Implementation of the eradication project and subsequent report	The Atoll is rodent free and remains so
	<ul style="list-style-type: none"> <li>• All islands on Palmerston Atoll remain free of rodents</li> </ul>	Biosecurity plan and implementation of biosecurity and ongoing reporting	Rats are prevented from impacting ecosystems on the other motu in the Atoll, and Home and Cooks motu ecosystems are improved and maintained in a healthy and functioning state.
	<ul style="list-style-type: none"> <li>• Ecosystem recovery</li> </ul>	Monitoring and reporting of outcomes	Long term, seabird numbers increase on Cooks motu.
Community/ Livelihoods	<ul style="list-style-type: none"> <li>• The community supports the eradication and ongoing biosecurity</li> </ul>	Community actions and attitudes are reported	The local community benefits from the rat free environment
	<ul style="list-style-type: none"> <li>• Increased food security for the Palmerston community</li> </ul>	Measurable increase in agricultural yields (quantity, quality and variety) reported by the community	An increase resilience of the community through more secure food production
Partnerships	<ul style="list-style-type: none"> <li>• Work collaboratively to achieve conservation outcomes with NES, TIS, MOA, and the Palmerston community</li> </ul>	The success of partnerships is reported on	Capacity and understanding of rodent eradications and project on

			management is built amongst partners
Knowledge	<ul style="list-style-type: none"> <li>Increased knowledge and capacity of in-country organisations and communities with invasive species management</li> </ul>	Individuals from partner organisations and the community are involved in delivering the eradication	Organisations and individuals have the capacity to provide experience to future invasive management projects
		Project documented	Capacity and knowledge are increased and shared

## 1.4 Key project stakeholders

The project has institutional support from multiple organisations, who's roles are identified in **Table 1.4** below. These organisations make up the Palmerston Working Group, which meets to discuss the project on a monthly basis.

**Table 1.4:** Institutional support and roles for the project

Institution	Type	Role
NZ MFAT	NZ government	<ul style="list-style-type: none"> <li>Funding</li> </ul>
NZ DOC	NZ government	<ul style="list-style-type: none"> <li>Project lead</li> <li>Operational planning</li> <li>Provide field staff</li> <li>Technical expertise to provide capacity building</li> <li>Part of Project Working Group</li> </ul>
Palmerston Island Administration	Cook Islands government	<ul style="list-style-type: none"> <li>Local knowledge and expertise</li> <li>Arrange local logistics and infrastructure</li> <li>Provide local staff</li> <li>Liaison to the community and Island Council</li> <li>Part of Project Working Group</li> </ul>
NES	Cook Islands government	<ul style="list-style-type: none"> <li>Governance</li> <li>Liaison with Palmerston Island Council and the community</li> <li>Lead community engagement</li> <li>Part of Project Working Group</li> <li>Advice around local legislation and regulations</li> <li>Provide field staff</li> </ul>
TIS	Cooks Islands NGO	<ul style="list-style-type: none"> <li>Lead on awareness raising</li> <li>Part of Project Working Group</li> <li>Provide field staff</li> <li>Support with in-country logistics</li> </ul>
MOA	Cook Islands government	<ul style="list-style-type: none"> <li>Lead on creation and implementation of biosecurity plan for Palmerston</li> <li>Part of Project Working Group</li> <li>Provide field staff</li> </ul>

## 1.5 Project team

**Table 1.5** outlines the field delivery team and their respective organisations and roles. project team structure for the pre-delivery and operational planning phase. **Figure 1.1** shows the reporting structure for this team, and **Figure 1.2** outlines the project structure for the pre-delivery and operational planning phase of the project. Note that team members can carry-out more than one role as activities are not necessarily conducted simultaneously.

Table 1.5: Palmerston eradication field team for project delivery in July/August 2023

<b>Field delivery team</b>	<b>Roles</b>
<b>Em Oyston (DOC)</b>	Project manager/team lead Grid layout GIS/Data Technical lead
<b>James Ware (DOC)</b>	Grid layout lead Baiting team lead Bait caching lead
<b>Michael Mitchell (DOC)</b>	Building baiting lead Grid layout Issues management lead Bait availability remeasures
<b>Alanna Smith (TIS)</b>	Grid layout Grid baiter Videographer
<b>Teariki Tearatoa (NES)</b>	Grid layout Community liason
<b>Tuaineiti Ngamata (MOA)</b>	Grid layout Grid baiting Bait caching
<b>Jenny Long (DOC)</b>	Monitoring lead Biosecurity lead H&S lead Assist data management
<b>Ieremia Samuela (TIS)</b>	Grid layout Grid baiting Bait caching
<b>TBC (PIA)</b>	Grid layout Grid baiting Bait caching
<b>Julianna Marsters (PIA)</b>	Grid layout Grid baiting Building baiting Bait degradation monitoring

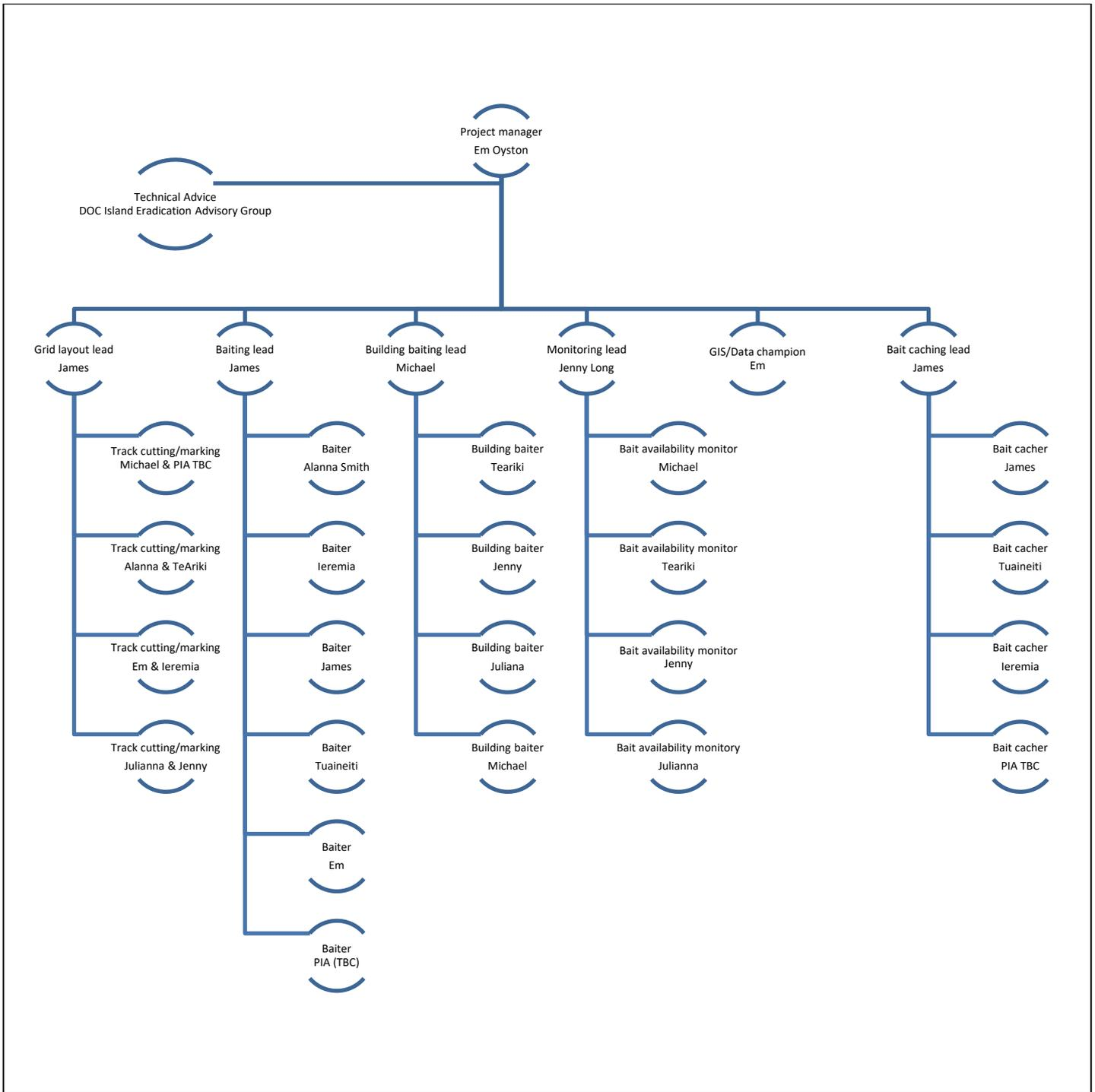

Figure 1.1: Team structure for the delivery/field phase of the project

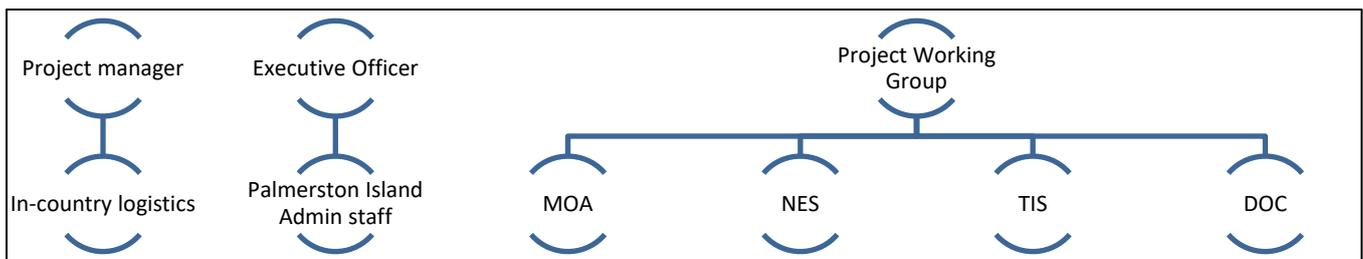

Figure 1.2: Team structure for the pre-delivery and operational planning phase of the project

## 1.6 Key Roles and Responsibilities

Table 1.6: Key roles and responsibilities for project delivery team

Position	Responsibilities	Period
<b>Project manager (Em Oyston)</b>	<ul style="list-style-type: none"> <li>Oversees project design, operational planning, and delivery of the project.</li> <li>Responsible for the project reporting and finances.</li> <li>Key contact for DOC for partner organisations involved with the project.</li> <li>Manages the team delivering the operation.</li> <li>Identifies and orders equipment needed for the operation phase.</li> <li>Arrangement accommodation and international travel</li> <li>Write H&amp;S and emergency response procedures.</li> <li>GIS and spatial planning for the operation blocks</li> <li>Calculate and order bait quantities.</li> <li>Media liaison for project</li> <li>Daily log of activities during phase 2</li> </ul>	Project period
<b>Logistics lead (Em Oyston)</b>	<ul style="list-style-type: none"> <li>Responsible for scoping and securing transport arrangements for freight (including bait) and passengers.</li> <li>Responsible for organising and accounting for field gear on Palmerston Atoll.</li> </ul>	Pre-field delivery
<b>In-country logistics (Kelvin Passfield – TIS)</b>	<ul style="list-style-type: none"> <li>Provides in-country logistical support need for the project</li> <li>Mostly related to the payment of local costs, and reimbursed by DOC</li> <li>Organising and purchasing food and freight to Palmerston for operational phases of the project</li> <li>Organises and provides storage required for field gear and bait in Rarotonga whilst enroute to Palmerston or NZ</li> <li>In-country contact for contacting suppliers etc</li> </ul>	Pre-field delivery
<b>Executive Officer (Arthur Neale – PIA)</b>	<ul style="list-style-type: none"> <li>Representative of the Cook Island Government on Palmerston Island</li> <li>Leads and delegates tasks to the Palmerston Island Administration staff</li> <li>Liaison between project manager, PWG, and the community/island council</li> <li>Organises island related logistics required by field team</li> <li>Ensures identified management issues (rubbish burn offs, household waste collection, agricultural harvests, and livestock culling) are adequately managed and monitored</li> </ul>	Pre-field delivery and during field delivery
<b>PIA staff</b>	<ul style="list-style-type: none"> <li>Carries out tasks as per instructed by EO</li> <li>Charlie Marsters responsible for household waste collection system</li> <li>Julianna Marsters lead PIA staff</li> <li>Other possible members include Daroma, Ray Charles, Dion, and John Marsters</li> </ul>	Pre-field delivery and during field delivery
<b>Palmerston Working Group</b>	<ul style="list-style-type: none"> <li>Represents collaborating agencies of the project</li> <li>Provides advice based on organisational perspectives</li> <li>Allocates organisational resources</li> </ul>	Pre-field delivery
<b>Grid layout lead (James Ware)</b>	<ul style="list-style-type: none"> <li>Responsible for the creation of a precise baiting grid on the operational blocks, which includes track cutting, and marking and labelling transects so they are easily to identify and follow for the baiting team</li> <li>Lead 7-9 staff who will work in teams of 2 to create, cut, and mark the grids</li> <li>Train and brief the grid/track team</li> <li>Delegate grid/transects areas to team</li> <li>Ensure high quality control of the grid/track teams and do quality control checks often on parts of the grid, and ensure work is redone if not up to standard.</li> <li>Record which areas have been done as they are completed</li> <li>Ensure grid points are GPSed and labelled appropriately (both on GPS and physically)</li> <li>Report back to the project manager on any issues identified</li> <li>Daily log of activities during Phase 1</li> </ul>	Field delivery period and preparation before and after
<b>Community issues review (Michael Mitchell)</b>	<ul style="list-style-type: none"> <li>Meets with each household to talk about any concerns/issues with the baiting</li> <li>Reviews identified community issues status (3.2.1-3.2.10) and that solutions are to the agreed standard</li> <li>Liaises and consults with Project manager on status of community issues</li> </ul>	Field delivery period
<b>Baiting team lead (James Ware)</b>	<ul style="list-style-type: none"> <li>Responsible for the allocation and spreading of hand broadcast bait during the operational phase on Palmerston Atoll.</li> <li>Lead and be part of a team of 4-6 who are hand broadcasting bait</li> <li>Train and brief the baiting team</li> <li>Delegate baiting transects to team</li> <li>Ensure baiters have the right amount of bait and caches available at the right places</li> <li>Record which areas have been baited as they are completed</li> <li>Quality control/spot check baited areas to ensure coverage/rates are correct</li> <li>Report back to the project manager on any issues identified</li> </ul>	Field delivery period and preparation before and after

<b>Building baiting team lead (Michael Mitchell)</b>	<ul style="list-style-type: none"> <li>Responsible for ensuring all buildings are identified for baiting and planning the delivery of the baiting. Special baiting will primarily be limited to Home Island</li> <li>Lead of team of 1-3 staff who will deliver the special baiting and baiting of infrastructure</li> <li>Train and brief special baiting team</li> <li>Coordinate and delegate the baiting and monitoring of baiting in buildings</li> <li>Map special baiting areas</li> <li>Record areas baited as they are completed</li> <li>Ensure follow up monitoring and bait replenishment is done on the planned timeframes</li> <li>Administer a spreadsheet/spatial database that records location of baiting, unique IDs for each bait tray, and monitoring and replenishment data associated with each bait tray</li> </ul>	Field delivery period and preparation before and after
<b>Monitoring Lead (Jenny Long)</b>	<ul style="list-style-type: none"> <li>Responsible for leading the establishment and monitoring of bait availability plots</li> <li>Responsible for ensuring bait and carcass degradation plots are established and monitoring is handed over</li> <li>Responsible for reviewing outer motu rodent presence data and recording this</li> </ul>	Field delivery period and preparation before and after
<b>Safety officer (Michael Mitchell)</b>	<ul style="list-style-type: none"> <li>Responsible for maintaining safety standards and providing input into daily briefings as necessary</li> <li>Identifies when review of safety procedures may need to take place due to change of task/conditions and liaises with activity lead and/or project manager</li> <li>Formally recording any incidents and ensure these are part of the debriefing process</li> <li>Take lessso</li> </ul>	Field delivery period and preparation before and after
<b>Biosecurity lead (James Ware phase 1, Jenny Long phase 2)</b>	<ul style="list-style-type: none"> <li>Ensures appropriate biosecurity procedures take place by team members and those involved with the transport of cargo to Palmerston in order to prevent unwanted organisms arriving in Palmerston as part of the project</li> <li>Risks include personal gear, field gear, and bait being stored and transported to the Atoll which may provide a pathway for unwanted organisms</li> <li>Ensures vessels are checked and cleared prior to inter-motu transport on Palmerston Atoll</li> <li>Helps leads the establishment of biosecurity infrastructure during phase 2 of the fieldwork</li> </ul>	Field delivery period and preparation before and after
<b>GIS/Data champion (Em Oyston, Jenny Long backup)</b>	<ul style="list-style-type: none"> <li>Coordinates data and spatial data storage in a clear logical structure with clear and consistent naming conventions</li> <li>Collects and pools photo and video library for project</li> <li>Ensures data is updated daily where relevant</li> <li>Checks data for errors</li> <li>Backs up data on a regular basis</li> <li>Produces operational updates for project needed (maps, data) when needed</li> </ul>	Field delivery period and preparation before and after

## 1.7 Timeline and Milestones

A detailed task timeline can be found in the [Palmerston eradication planning sheet](#). A summary of key tasks and milestones can be found in **Table 1.7** below.

**Table 1.7: Summary of key tasks (with milestones highlighted in orange)**

Task	Who	When	Completed?
Palmerston Working Group	PWG members	Monthly	✓
Resources received on Palmerston for addressing eradication related issues to be managed by community	PIA	February 2023	✓
Feedback received from IEAG on feasibility study	Em	March 2023	✓
Budget confirmed and approved by governance group	Souad	March 2023	✓
Field team members confirmed	Partner organisations	April 2023	✓
Vessels between Rarotonga and Palmerston secured	Em	April 2023	✓
Operational Plan drafted	Em	May 2023	✓
Biosecurity review and report/recommendations provided	Contractor/Souad	May 2023	✓

Bait and field-gear depart from NZ for Rarotonga via sea freight	Shuttle express/Em	May 2023	✓
Task specifications finalised	Em	June 2023	
Feedback from IEAG on Operational Plan	Em	June 2023	✓
Bait arrives on Palmerston	Kelvin	July 2023	
Field teams and field gear arrive on Palmerston	Em	August 2023	
Baiting grids established	James	August 2023	
Confirmation of community management issues completed to standard	James/Michael	August 2023	
Building baiting plan confirmed	Michael	August 2023	
First bait applications completed	Em	August 2023	
Bait availability monitoring assessed	Em and Jenny	August 2023	
Second bait applications completed	Em	September 2023	
Demobilisation of marked grids	James	September 2023	
Biosecurity surveillance infrastructure established on Palmerston	Jenny and James	August/September 2023	
Field-team departs Palmerston	Phase 2 team	September 2023	
Operation reporting and debrief completed	Em	September 2023	
Caution period lifted	Julianna and Em	Based on carcass and bait degradation monitoring but likely by December 2023	
Confirmation on eradication success/Results monitoring completed	Em	March 2024	

## 1.8 Project dependencies, risks, and mitigations

Risk and dependencies ultimately relate to fundamental eradication principles of 1) Every rat has access to bait (accessibility), and 2) every rat will eat a bait (palatability) and 3) biosecurity measures prevent rats dispersing during the operation or reinvading (sustainable). If any of these three principles are not achieved, the eradication will fail.

The project team has identified the baiting operation should take place between July-September to coincide with what is most likely the lowest period of rainfall during the year, meaning bait will be available for longer; it is the less productive time for naturally occurring food resources; the period of the year when rats are less likely to be breeding; and lower rainfall potentially leading to less non-target (crab) bait consumers.

Specific risks and dependencies outlined in the feasibility study are outlined in **Table 1.8** below.

**Table 1.8:** Summary of project risks and dependencies

Risk	Dependency	Reference (from feasibility study)	Mitigation if dependency not realised
Agricultural produce present on Home Island will decrease bait palatability to rats, thus causing eradication failure	Palmerston community eliminate/remove agricultural produce from Home Island prior to the bait phase of the eradication	Section 3.5, page 12	Phase 1 team to assist removal/harvest and disposal
Wild and domesticated chickens on Home Island are likely to consume significant amounts of bait, leading to decreased bait availability for rats, resulting in the failure of the eradication	Domestic chickens must be removed from Home Island, and wild chickens must be significantly reduced – prior to the delivery phase of the eradication. This must be led by the community.	Section 3.5, page 13	Field team will put effort into removing chickens with community on arrival
Livestock (pigs and chickens) on Home Island will consume bait and also present alternative sources of food (manure and food scraps) for rats. Non-target bait consumption and alternate food sources are likely to lead to eradication failure.	Livestock must be removed from Home Island before the delivery phase of the eradication begins.	Section 3.5, page 13	Livestock all to be culled
Baiting team are unable to get access to all buildings resulting in some rats not being able to access bait	The Palmerston community are able to unlock and gain access to every building on Home Island, and the baiting team are able to bait all buildings and manoeuvre within buildings (meaning clutter may need to be reduced).	Section 5.3, page 25	Have been assured all buildings can be accessed.
There are a number of alternative food sources including household waste, greywater, livestock, rubbish piles, food waste that need to be managed/eliminated in order to ensure rats consume bait	The Palmerston community sufficiently carry out the agreed management actions as per Table 3. High priorities include rubbish burnoff, household rubbish and waste management systems, eliminating agricultural produce during the operation period, and removing livestock from Home Island	Section 5.3, Table 3, pages 26	Team to assist and encourage quality assurance in rubbish disposal; additional bait broadcast in areas of risk
Management of issues, grid construction, and/or baiting is done poorly/to a low standard, resulting in failure due to all rats not having access to bait or bait having low palatability.	For the operational phase, the project needs to ensure it has enough team members with animal pest control experience and an eradication mindset. This is likely to mean that 50% of the delivery team will consist of DOC/NZ staff. This will also increase the exposure of experience to partner agency staff for the benefit of capacity building.	Section 7.2, pages 35-36	Team lead ensures good quality control and monitors regularly
Unable to get staff or freight to the Atoll; or transport of the delivery phases is delayed, pushing the operational phase into sub-optimal climatic conditions that increase the risk of failure.	Suitable transport vessel/s can be secured in the time periods required, that can take the number of passengers and freight volume required to and from the Atoll,	Section 7.5, pages 7	Postpone operational phases until availability;
Appropriate biosecurity procedures are not in place, leading to a future rodent incursion on Palmerston after the eradication effort	Pragmatic biosecurity measures to implement are identified, and these are uptaken by the Palmerston Community at a minimum. Biosecurity of relevant vessels and the port in Rarotonga are reviewed and guidelines/actions identified and implemented.	Section 7.6, page 37	At a minimum, biosecurity surveillance equipment is present in Palmerston before fieldteams demobilise on the island

## 1.9 Consents required

**Table 1.9** outlines the permissions/consents required for the operation. Precedent for the import and use of PestOff 20R in the Cook Islands has been set by the use of it for cyclic control of rodents in the Takitimu Conservation Area (Rarotonga), and for several rat eradication attempts on Suvarrow Atoll.

**Table 1.9:** Regulatory permissions required for proposed eradication project

Consent/Permit required	Granted by	Received?
Formal community approval for access to motu and broadcasting bait	Mayor on behalf of Island Council and community	August 2022
Import of bait into the Cook Islands	MOA	Confirmed in PWG in February 2023 that this would not be required
Environmental Significance Declaration	NES	September 2022

## 1.10 Community consultation

The Palmerston community are supportive of the eradication, and the original request for the eradication came from the community and Island Council. The feasibility field trip conducted in November 2022 allowed dialogue and presentations to understand what the community wants and inform them of what an eradication would require of the community, and the impacts it would bring to their day to day lives prior, during, and after broadcasting toxic bait. The two main concerns the community had were around toxic baits and children, and the perception that poisoned rats would seek out residential water tanks to die in, and therefore contaminate drinking water. The actual risks and pathways around the realities of these concerns were discussed with the community by the project team and concerns were largely mitigated.

Government representatives of the community (Executive Officer, Island Council, heads of families) all support the eradication of rats on the Atoll.

## 1.11 Training requirements

As part of the field delivery project, specific training will need to be provided on a range of the activities undertaken. This will predominantly be from DOC staff to partner Cook Island organisations and Palmerston Island Administration staff. Specifically, training will need to be provided to Palmerston Island Administration staff on the following activities which they will need to continue once the field team have departed:

- Bait and carcass degradation monitoring
- Biosecurity infrastructure monitoring
- Building baiting monitoring and record keeping

## 1.12 Project debrief and reporting

Team debriefs will be held each day while in Palmerston, based on the activities completed. An end of trip debrief will also occur (on Palmerston) around the delivery phase of the project as a whole. There is a role allocated to running morning and end of day briefings during the fieldwork period ('Briefer').

An operations summary report will be written in September/October when field staff have returned home. This operations report will provide a summary of the work completed and relevant operational details associated with the eradication.

The report will include a summary diary of activities from each day, as well as include a summary of operational debriefs, and recommendations.

The report will be amended with bait and carcass degradation results when these are available and communicated by the PIA.

A project debrief is likely to be facilitated by the DOC MISCCAP project manager post September 2023 once the delivery phase of the project is complete.

## Section 2: Site context

### 2.1 Location and physical environment

Palmerston Atoll lies in the middle of the Pacific Ocean, being the Northern most of the Pa Eヌua (outer islands) within the Southern Group of the Cook Islands (see **Figure 2.1**).

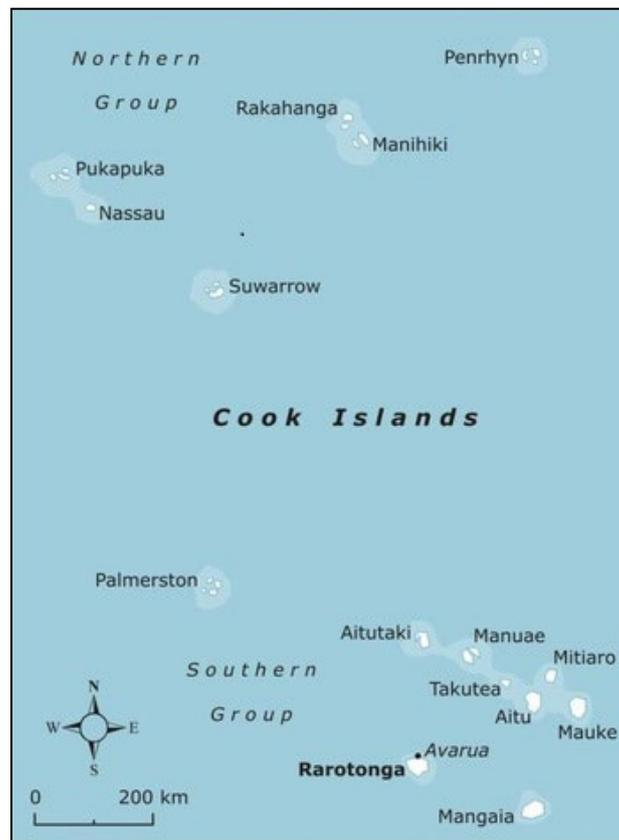

**Figure 2.1:** Palmerston Atoll and the wider Cook Islands

Its nearest neighbours are Suvarrow Atoll 500km to the north, Aitutaki 367km to the southeast and Rarotonga, the country's capital, 500km south. The island country of Niue is 700km to the west. The Atoll consist of six vegetated islands (referred to as motu) ranging from 12 to 42ha, with a number of <1ha sandbanks that are unvegetated (see **Figure 2.2**). The distance between each of the islets varies from 900m to 7km. Rats are present on Home Island (ship rats and kiore) and Cooks motu (kiore). The Atoll's lagoon is approximately 11km across, covering approximately 5700 ha, with total land area of the motu covering approximately 183ha.

Home Island, also known as Palmerston Island, is the only inhabited islet in the Atoll, and holds the highest point of land in the atoll at 5mabsl. It has a total land area of 36 hectares, and is over 2100m distance to the next closest motu (Cooks motu to the south-east).

Cooks motu consists of several motu and sandbanks that have been fragmented by significant storm events (see **Figure 2.3**). It consists of the Dicky Boy Sandbanks, and Calcutta and Aparanuta motu; with a total area of 29 hectares. The next closest motu is Toms, which is approximately 850m away to the east-south-east.



Figure 2.2: Palmerston Atoll and associated motu and sandbanks

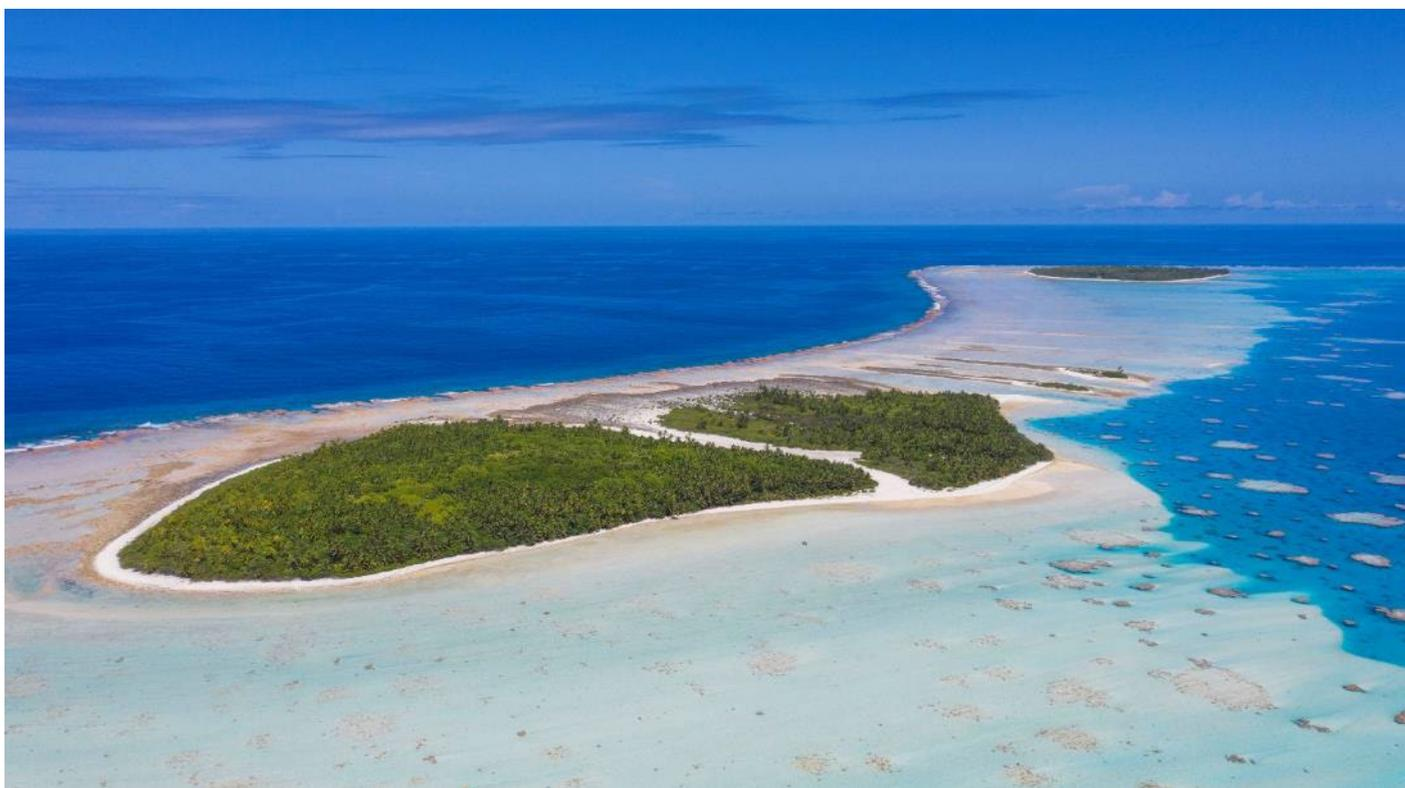

**Figure 2.3:** Cooks motu group (from left to right consisting of Aparanuta, Calcutta, and the two Dicky Boy Sandbanks), and Home Island in the distant right. These are the islets/motu that are part of the operation blocks

## 2.2 Climate

Common to most tropical islands, Palmerston experiences distinct wet and dry seasons; "Wet" from November through to April which coincides with the cyclone season (when tropical cyclones are more likely, restricting access) "Dry" from May to October. Although this is the general trend, significant isolated rain events can occur anytime through the year. Feedback from the community has been that weather patterns in recent years have been less predictable than in the past and the weather has been wetter than usual in the past couple of months, which has slowed on-island preparations.

An automatic weather station was installed on the island in 2020, and specific climate data for Palmerston exist only for the 2021 year (see **Figure 2.4**). From this data, temperature is relative constant year-round (mean annual temperature is 28 degrees Celsius), and total annual rainfall was 2038mm. The next closest proxy for climate data is Rarotonga, with receives an average of 1600mm of precipitation annually (see **Figure 2.5**).

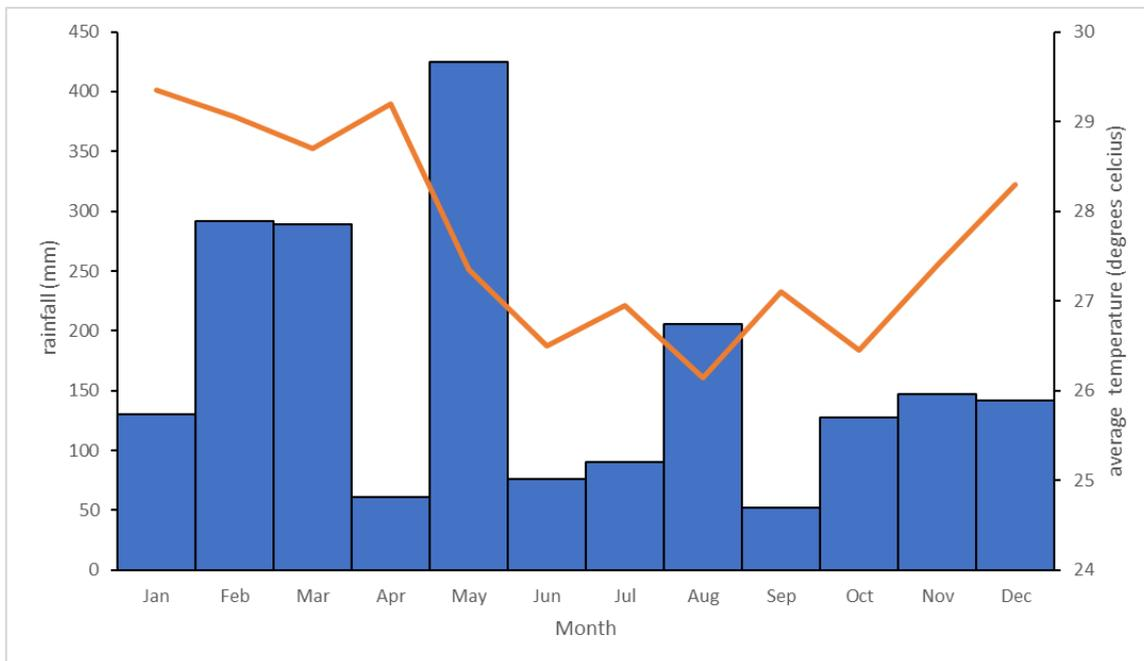

Figure 2.4: Palmerston Atoll AWS data for 2021

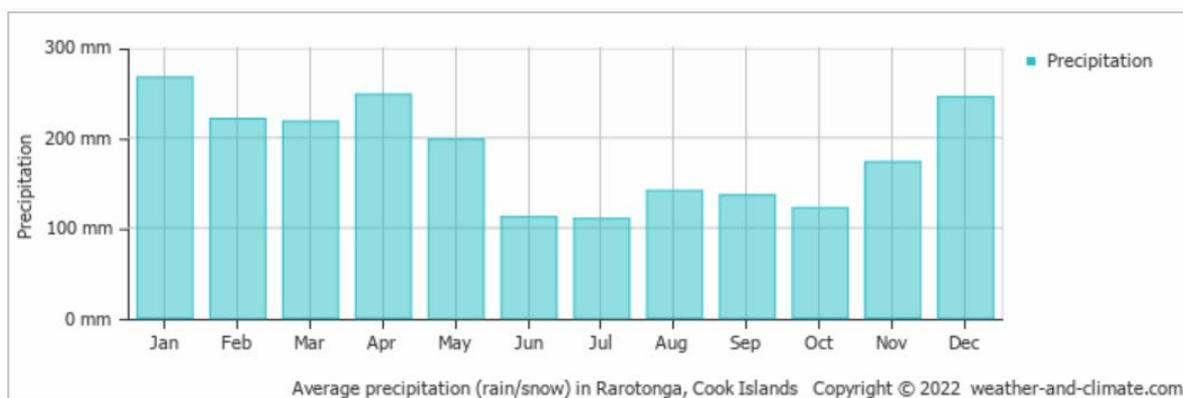

Figure 2.5: Average precipitation in Rarotonga, Cook Islands

## 2.3 Social structure

The expected population of Palmerston on arrival of the field teams in June 2023 is Atoll is 34. The current population is spread between 7-8 households.

Palmerston has its own island government, established under the Island Government Act 2012-13. It consists of the Mayor (currently Bill Marsters), elected from any of the individual heads of the three families, three other representatives of the three families, and the Member of Parliament who resides in Rarotonga. Members of the Council are elected according to the island customs. An Executive Officer (currently Arthur Neale) is also appointed by the Island Government, after approval by the Public Service Commissioner, and is the senior public servant on the island. Under the Island Government Act 2012-13, the Island Council can make by-laws for the licensing and regulation of any activities or matters affecting the island.

The community are devout practicing Christians. Sundays are observed as a day of rest, with church attended between 1000-1100hrs in formal long pants and shirts, and work, loud noise, and exertion being prohibited on Sundays. It will not always be possible to observe this given the tasks associated with the eradication, so this should be discussed with the Pastor, EO, and Island Council on arrival by the team lead. The first Sunday of each month is known as ‘White Sunday’, where white tops must be worn on church attendance.

## 2.4 Land use and tenure

Land on all of the motu are divided between the three family branches who hold customary land legal status (Figure 2.6 shows demarcation of family land boundaries on Home Island). Some islets such as Primrose are divided between two families. The head of the family gives the rights of access to their family areas/sections on the motus. Individual residential sections on Home Island are considered private property, with ownership belonging to the homeowner. For other open spaces within a common family boundary, the Family Head is in charge. For the purposes of the eradication, the Family Heads have given their support for the project to be carried out where needed.

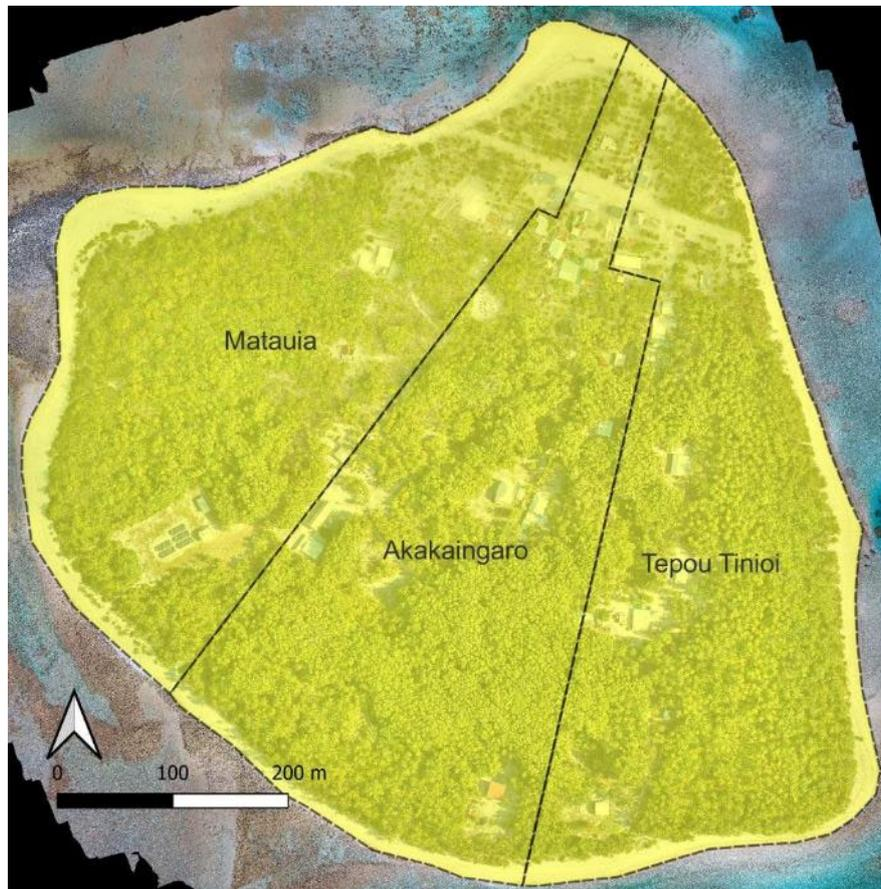

Figure 2.6: Demarcation of family land on Home Island

Land use on Home Island is a mixture of residential and non-residential buildings, some small-scale agriculture and fruit trees, and for small scale semi-domesticated livestock (pigs and chickens). It is also the base for small dinghy operations that are at work most days for the purpose of commercial and subsistence fishing. The Palmerston community rely heavily on a partially-subsistence livelihood, with a focus on marine resources such as parrot fish for subsistence and commercial export to Rarotonga. Palmerston has the highest fish consumption per capita in the world (Pinca et al., 2009); which is supplemented by fruits and vegetables grown on the island. A hydroponics shed with planters produces tomato, cabbage, lettuce, cucumbers, bok choy, and beans. Other locally grown food sources include coconut, banana, mango, pawpaw, lime, pūraka (swamp taro), sugarcane, breadfruit, bamboo, kumara, dragonfruit, arambola (rapa), nenu (nono, noni), tuava (wild guava) and arrowroot.

Pigs are kept as domesticated livestock. Several hundred wild chickens exist over Home Island. Wild chickens are occasionally harvested for meat, but not relied on. 'Semi-domesticated' chickens also exist, which are fed at common points close to residential buildings but roam freely. Eggs are sometimes found opportunistically for consumption, but like meat, are not relied on.

Fifteen pigs in total are kept between all households on Home Island. Some pigs are penned in simple pens constructed from coconut trunks; some are tethered by rope, and some walk freely but do not range out of residential lots.

## 2.5 Existing infrastructure

There are 18 residential/residential accessory buildings, and a total of 66 non-residential buildings (storage, facilities, infrastructure, and dilapidated) located across Home Island. During the eradication period the population is likely to be between 30 and 40 people, occupying a total of 10 – 11 residential dwellings. Some of the non-residential buildings on Home Island include the administration building, school, government building, Christian church, cyclone shelter, fuel depot, hydroponics shed, Vodafone satellite station and solar power station. The settlement has been fully solar powered since 2015 but also uses a 36kwh generator in addition to solar generation and battery storage. Refrigeration and freezers are present, which support the small fish export market to Rarotonga.

Water supply is from rainwater collected household and accessory building rooves and stored in tanks. There are also formed wells that are covered, dotted throughout Home Island that are seldom used (not for drinking). There are 3 graveyards on Home Island and one in the yard of a house. Many homes have flush toilet systems and grey water septic systems that lead to an underground septic tank, however some buildings and homes utilise long drop toilets, and greywater from kitchens runs into uncovered pits.

A community medical room is present that provides a basic level of pre-hospital care and stabilisation, including a defibrillator. A trained nurse is present in the community. Patients are required to be evacuated by vessel for hospital level care.

Cellular phone (Vodafone), a 'fixed' telephone to Rarotonga, and satellite internet are all present to a limited extent on Home Island. VHF communications to vessels take place on VHF Channel 16.

There is a working excavator, quad bike, tractor, and trailer for unloading supplies as well as three heavy machines which are not currently operational.

There are several small passages through the reef for small boats, however there is no safe entry for large ships. The Atoll is out of range to service by helicopter and has no infrastructure to accommodate fixed wing aircraft landings. Thus the residents rely on inter-island shipping for transportation and food supply. Supplies come once every 3-4 months on average via a freight boat that travels between the Pa Enua, but these have been less frequent since the 2020 COVID pandemic. Pre-COVID, small cruise ships and yachts visited the island, creating additional revenue for locals. In 2016 a total of 64 yachts visited the atoll (TIS 2020).

All yachts visiting are required to have a health and agriculture/quarantine clearance, which is authorised by the Executive Officer on Home Island. Crews must remain onboard until the required checks and clearance is complete.

## 2.6 Conservation Values

Palmerston Atoll is part of the Polynesia-Micronesia Biodiversity Hotspot, one of 34 regions in the world where extraordinary levels of biodiversity and endemism are coupled with extremely high levels of threat (Mittermeier et al. 2004).

### Flora

Much of Home Island has been heavily modified due to the presence of residential use, infrastructure, agriculture, and livestock. There are still tracts of wooded canopy trees, but the canopy is generally less diverse than the uninhabited motus, dominated by (*Cocos nucifera*) and Pacific Mahogany (*Calophyllum inophyllum*).

The other motu (including Cooks) have had significantly less vegetation clearance, and generally consist of larger trees located centrally and protected from constant salt spray and periodic inundation from the ocean. These include coconut (*Cocos nucifera*), Pacific Mahogany/Tamanu (*Calophyllum inophyllum*), Pukatea (*Pisonia grandis*), 'Ano (*Guettarda speciosa*), 'Ara (*Pandanus tectorius*), Tou (*Cordia subcordata*), Tutu (*Colubrina asiatica*), the Lantern Tree (Puka or *Hernandia nymphaeifolia*), and occasionally Toa (*Casuarina equisetifolia*). Understory vegetation is dominated by saplings, ferns, and Indian Mulberry (*Morinda citrifolia*). Salt-tolerant plants common to most Pacific Islands in the tropic zone surround the taller, centralised wooded vegetation. These include Ngangie Raupunupunu (*Pemphis acidula*), Beach Heliotrope (*Messerschmidia argentea*), Rakau pakari (*Timonius polygamus*) and *Scaevola taccada*. Occasionally the strand shrub Ngangie Moe (*Suriana maritima*) can be observed.

## Fauna

Palmerston has been known for several decades as one of the most important sea turtle nesting sites in the Cook Islands (TIS 2020). This includes the Green turtle (*Chelonia mydas*) and Hawksbill turtle (*Eretmochelys imbricata*), listed as endangered and critically endangered respectively. Harvesting of turtle eggs and commercial harvest of turtles was once common but has largely ceased, although the community have mentioned some individuals succumbing to the commercial demand for turtle meat in Rarotonga on occasions. Cooks motu is a key turtle nesting site, with 24 nests (4 times more than any other motu) found there in 2018 (TIS 2020).

Two species of hermit crabs (*Coenobita brevipennis* and one other *Coenobita* spp.), at least one species of land crab (*Cardisoma carnifex*), and coconut crabs (*Birgus latro*) are present on the Atoll. The latter is listed as 'vulnerable' on the IUCN Red List, but have healthy numbers on Toms, Primrose, Bird, and North Atolls. Land crabs and coconut crabs are absent from Home Island but present in relatively low numbers on Cooks. Low numbers/absence of coconut crabs on Cooks and Home is likely due to harvesting pressures of humans and possible due to predation of young by rodents.

The atoll acts as a layover site for migratory seabirds such as the wandering tattler (*Tringa incana*), pacific golden plover (*Pruvialis fulva*), ruddy turnstone (*Arenaria interpres*), and the bristle thighed curlew (*Numenius tahitensis*). The latter is listed as 'vulnerable' on the IUCN Red List. Palmerston also acts as a nesting site for other seabirds such as the red-tailed tropic bird (*Phaethon rubricauda*), brown and black noddy (*Anous stolidus* and *A.minutus*), brown booby (*Sua leucogaster*), greater and lesser frigate bird (*Fregata minor* and *F.ariel*), white tern (*Gygis alba*) and red footed booby (*Sua sua*). The Pacific pigeon (*Ducula pacific*) is the only land bird.

## 2.7 Threats

Ship rats (*Rattus rattus*) and kiore (*Rattus exulans*) are both present on Home Island, and kiore are present on Cooks motu. Significant rodent detection effort took place on the Atoll in November 2022 to provide a high level of confidence that rodents are absent from all other motu (see DOC 2022). This is reinforced by the 2018 baited coconut crab surveys across vegetated motu that also observed rodents only on Home and Cooks (Kora and Munro 2020).

From site visit fieldwork undertaken in November 2022, kiore were found across all broad habitats surveyed on Home Island and Cooks motu. Catch rates for kiore did not appear to significantly differ between broad habitat types on Home Island. The condition of kiore on Cooks was found to be significantly better compared to Home Island (body size larger and heavier), which may correlate to food availability on the relevant motu.

Results from previous fieldwork also suggested kiore to be dominant over ship rats, with only one ship rat being caught for every ten kiore caught. The five ship rats caught were all caught in one particular area on a single transect, rather than from traps across the island. This finding of kiore dominance is inverse to the normal relationship in which ship rats are the dominant species and are known to successfully displace kiore from most

environmental niches and largely outcompete kiore over much of its global range where the two species overlap (Spennemann 1997; Atkinson 1985; Long 2003; Varnham 2010).

The presence of ship rats on Palmerston Atoll increases the chances of self-establishing populations on the outer motu due to the swimming ability of ship rats compared to kiore. Ship rats are documented swimming up to 800m (Keith Broome Pers comms.) in cooler temperate waters in New Zealand, and this distance could potentially increase in the warmer tropic waters of the Palmerston Atoll lagoon. Kiore on the other hand are relatively poor swimmers, with many examples in the tropics where parts of atolls have remained uninvaded by kiore when existing <50m from source populations (Richard Griffiths Pers comms.).

## Impacts

The eradication of rodents from Palmerston will have significant benefits for both biodiversity and the livelihoods of people living on Home Island.

The impacts of introduced rats on biodiversity and island ecosystems is well documented. Introduced rats have a significant impact on island ecosystems and have been one of the leading causes for species extinctions of mammals, birds, invertebrates, and reptiles (Atkinson 1985; Towns et al. 2006, Hutton et al. 2007; Duncan and Blackburn 2007). Rodents have significant impacts on seabirds, preying upon eggs, chicks, and adults and causing population declines, with the most severe impacts on burrow-nesting seabirds (Atkinson 1985; Jones et al. 2008; Towns et al. 2006). In addition to the predation of fauna, rodents feed opportunistically on plants, and alter the floral communities of island ecosystems (Campbell and Atkinson 2002); in some cases degrading the quality of habitat for fauna that depend on the vegetation (Wegmann 2009, Young et al. 2010).

On Palmerston Atoll, there is a noticeable absence of seabirds present on Home and Cooks Island relative to the other vegetated motu which are rat-free. Both kiore and ship rats are likely to have a negative impact on bird species that breed on these islands, especially the smaller ground-nesting species, due to direct predation of eggs, chicks and nest disturbance.

Rats have been acknowledged as a possible predator of young coconut crabs, which could be particularly vulnerable due to their smaller size and soft shells at earlier life stages (Harper & Bunbury 2015, Samaniego et al. 2019). Rats are also known predators of turtle eggs and hatchlings, which is off particular concern for Cooks motu which has been identified as a relative stronghold breeding area for turtles.

The effects of rats on the livelihoods of the Palmerston community are obvious. All food and stores must be kept in sealed containers, otherwise they are prone to being consumed or contaminated by rats. Agricultural yields are diminished as rats consume crops such as cucumbers, coconuts, mangos, and guava. Where infrastructure exists, rodents feed, chew holes, urinate, and defecate – often ruining household items and clothing. There is a potential increased risk of diseases such as leptospirosis and salmonellosis due to the presence of rodents in commensal areas. As such the eradication of rats will lead to increased food security, reduction of stress, reduce the risk of illness; and make time available for other activities.

## Control history

Sporadic attempts of rat control take place on Home Island, with snap traps placed in homes, and rodenticide blocks also used in several households. Rodenticide blocks which have historically been used are 'Rentokil rat blocks' - 20g blocks containing the active second generation anticoagulant bromadiolone (0.05g/kg). Blocks are often left open around households, or in open cans that are attached to trees.

## Section 3: Operational

### 3.1 Overview

The eradication will take place over four operational phases as summarised in **Table 3.1** below. This section of the operational plan will provide detail around each of these phases.

**Table 3.1:** Summary of Palmerston Atoll rat eradication operational phases

Phase	Timeframe	Summary of phase output
<b>Community preparation</b>	February - July 2023	<ul style="list-style-type: none"> <li>Domestic greywater systems contained and sealed</li> <li>Baited camera trap monitoring of North, Karakarake, Primrose, and Toms islets to confirm absence of rats</li> <li>Harvest all agricultural produce and dispose, freeze, or store in rodent proof containment</li> <li>All food contained in rodent proof containers</li> <li>Cull all pigs</li> <li>Cull all chickens</li> <li>Ensure every building is accessible</li> <li>Declutter houses and yard surrounds to allow good physical and visual access during baiting and reduce potential rat habitat</li> <li>Ensure all rubbish holes and coconut piles have been burnt hot, then rubbish is to be consolidated to a single site managed by the PIA</li> <li>Establish a clean, consolidated, and contained household waste system that will be collected and managed by the PIA</li> <li>Island council to instigate clear and practical biosecurity standards to prevent rodents re-establishing on the Atoll. Monitored by PIA</li> </ul>
<b>Bait cargo to Palmerston</b>	June 29 <sup>th</sup> - 31 <sup>st</sup>	<ul style="list-style-type: none"> <li>Bait (600 x 10kg polypails) clears customs in Rarotonga and loaded into Taio shipping vessel Lady Moana</li> <li>Lady Moana departs Rarotonga morning of the 29/6</li> <li>Arrives in Palmerston morning of the 31/6. Bait ferried by island barge and small boats to beach where it is transported immediately to storage site in shade and wind flow under Reverend Tere's house</li> <li>Bait stacked</li> </ul>
<b>Phase 1: Grid construction and issues management</b>	14 days on atoll - Departing Rarotonga 4 <sup>th</sup> August	<ul style="list-style-type: none"> <li>Team of 10. 8 will travel including from Rarotonga (4 DOC staff, 2 x TIS staff, 1 MOA staff, and 1 NES staff) to join 2 PIA staff on Palmerston</li> <li>Unload and secure field gear on Island</li> <li>Community meet and greet, and briefing of phase</li> <li>Cut, mark, and record 20 x 20 metre grids on operational blocks (Cooks and Home)</li> <li>Review community preparation and identify any further management required. Assist further preparation if needed</li> <li>Creation of building baiting plan</li> </ul>
<b>Phase 2: Baiting</b>	21 - 28 days on atoll - August/September	<ul style="list-style-type: none"> <li>Team of 10 based on Atoll from phase 1.</li> <li>Community briefing of phase</li> <li>Monitoring and ensuring Home island alternate food availability measures are adhered to</li> <li>Bait bucket caching</li> <li>2 hand broadcast bait applications, supplemented by building baiting; spaced 10 days apart</li> <li>Bait availability monitoring on operation blocks for 5 days (including day of application)</li> <li>Trail camera monitoring at 10 points within bait transects</li> <li>Demobilisation of grid</li> </ul>
<b>Phase 3: Post-bait application</b>	Up to several months post- bait application. Estimated August - October 2023	<ul style="list-style-type: none"> <li>Monitoring and ensuring Home island alternate food availability measures are adhered to for one month post last bait application</li> <li>Monitoring and topping up bait trays until no bait taken for one month</li> <li>Monitor bait and carcass degradation plots</li> <li>Remove bait trays from building one month post last bait consumption</li> <li>Arrangement of new livestock (pigs and chickens) to the island once bait degradation monitoring has confirmed complete breakdown of bait and carcasses</li> </ul>

## 3.2 Community preparation phase (February – July 2023)

The community preparation phase consists of tasks to be done by the community that will address previously identified issues that have the potential to reduce bait accessibility or palatability for rats – ultimately resulting in eradication failure. These actions have been agreed upon and endorsed by the Island Council and Executive Officer, and are to be carried out prior to field teams arriving on Palmerston; led by the Executive officer and the Palmerston Island Administration staff.

The EO will provide an update on progress of these tasks at the monthly Palmerston Working Group meetings, as well as communicating with the Project Manager any issues that are encountered. The general contingency for any of these actions not being completed to standard is for the phase one team to help action them on arrival, but it has been agreed that the community will own and carry out these tasks.

Tasks to be completed in this phase are described below.

### 3.2.1 Disposal of agricultural crops and produce

- Issue:** Agricultural crops and fruit trees present a food source for rats
- Action:** All agricultural crops and fruit trees on Home Island must be harvested and disposed off/frozen/contained in rodent proof storage so that no food sources to reduce alternative food sources for rats. Known plants/crops include sugarcane, guava, banana, raprapa, breadfruit, sweet nuts, and the hydroponic/school gardens.
- Resources:** Individuals in each household, likely to take some time (allocate a week).
- Timeframe:** Completed at least one week in advance of baiting, so likely by mid of July.
- Responsibility:** Individual households, sanctioned by Island Council. Progress monitored by EO and reported to PWG monthly.

### 3.2.2 Culling of pigs on Home Island

- Issue:** Pigs can provide an alternate source of food for rats through pig feed and excrement. Pigs will also be big non-target consumers of bait reducing bait availability to the target species.
- Action:** Pigs are culled, or transported and contained on Primrose Island. The former is preferable, with all but one household agreeing to cull their pigs, and one household unsure and want to trial captivity on Primrose in April before deciding.
- Resources:** Each household to cull their own pigs. Pigs can be frozen for a food source for households. Household wanting to trial penning must do this at their own expense. Project to provide 15 replacement pigs (including transport) when monitoring shows no risk of primary or secondary poisoning exposure from bait and carcasses.
- Timeframe:** All pigs culled by end of June. Family trialling their pigs at Primrose need to decide what they will do by end of June.
- Responsibility:** Individual households, sanctioned by Island Council. Progress monitored by EO and reported to PWG monthly.

### 3.2.3 Culling of chickens on Home Island

- Issue:** Chickens could consume significant amounts of bait, reducing availability for rats. There is also risk of sub-lethal poisoning of chickens that then presents a risk of human poisoning.
- Action:** A significant effort needs to go into removing all chickens from Home Island. While eradication may not be possible, a significant reduction will reduce risk of operation failure.
- Resources:** Local community culling and trapping
- Timeframe:** Completed by mid July, ideally end of June.

**Responsibility:** Individual households, sanctioned by Island Council. Progress monitored by EO and reported to PWG monthly.

### 3.2.4 Containment of grey water systems

**Issue:** Open greywater systems at occupied residential dwelling present a food source for rats

**Action:** Individual occupied households (11) to install contained septic systems

**Resources:** PIA to provide cement, piping, and barrels. DOC to reimburse through via TIS

**Timeframe:** Completed by the end of June.

**Responsibility:** Individual households, sanctioned by Island Council. Progress monitored by EO and reported to PWG monthly.

### 3.2.5 Burning off past rubbish holes and coconut husks, and consolidating rubbish burning

**Issue:** Most households have at least one rubbish hole where rubbish is burnt off. Most of these rubbish holes act as habitat for rats, and burrows are visible on the side of rubbish holes. Large piles of used coconut husks are also present and potentially act as habitat and a food source for rats. There is a risk that rubbish holes and coconut piles provide refuge and food for rats, which could lead to reduced bait palatability.

**Action:** All rubbish holes and husk piles to be burnt 'very hot', and from that point on, rubbish burn off is consolidated to one burning drum managed by PIA.

**Resources:** PIA to provide and manage burning drum and rubbish collection/management system

**Timeframe:** Burn offs completed by the end of June, consolidation and management of single point of rubbish burning begins in mid - June.

**Responsibility:** Individual households, sanctioned by Island Council. Progress monitored by EO and reported to PWG monthly. Rubbish burn off and rubbish collection from May managed by PIA.

### 3.2.6 All stored food contained and is inaccessible to rodents.

**Issue:** If household food is stored in a way rat can access it, then bait palatability can potentially decrease and lead to eradication failure.

**Action:** Ensure all household food is stored in rodent proof containers.

**Resources:** Households to identify to PIA if additional containers/containment is needed.

**Timeframe:** Mostly in practice already, but needs to be monitored for 100% compliance.

**Responsibility:** Individual households, sanctioned by Island Council. Progress monitored by EO and reported to PWG monthly.

### 3.2.7 All buildings are accessible for baiting, and clutter is reduced/cleared

**Issue:** In order for every rodent to be able to access bait, all buildings must be accessible to the baiting team. So interior and exterior of buildings require a cleanup in order to reduce potential rodent habitat, and to safely allow access for baiting.

**Action:** Reduce and tidy clutter, access to every building possible.

**Resources:** Households or relatives to clean and clear.

**Timeframe:** Complete by the end of June.

**Responsibility:** Individual households, sanctioned by Island Council. Progress monitored by EO and reported to PWG monthly. Head's of family to have access to any locked building of buildings on family land, if buildings are unoccupied.

### 3.2.8 Household waste cleaning, collection, and consolidation management

- Issue:** Rubbish and packaging is currently dumped in rubbish pits to be burnt at a later date, and household food waste is fed to pigs or chickens. Fish guts/cleanings are disposed of on the beach, but residues are often present around cleaning area. After removal of flesh/water, coconut husks are left in piles or discarded. All of the above are potential food sources for rats which if not managed during the eradication could lead to reduced bait palatability and increase the likelihood of failure.
- Action:** A household waste management system must be instigated where rubbish and packaging is cleaned immediately after use, then sorted (separating foodwaste, burnables, and non-burnables), and immediately stored in sealed containers at each household. Household sealed containers will be collected each day and consolidated at a central place to be stored, and foodwaste will be disposed of outside of the reef, while burnables will be burnt at a single location in a single burning drum. Household food waste includes the containment of fish cleanings, and used coconuts.
- Resources:** Sealable plastic drums and buckets for each household (community to calculate volume required, with enough spares to allow a daily interchange with clean bins). PIA to identify how many large plastic sealable drums are required for storing non-burnable/non-food waste over a 2 month period. 40 gallon drum for contained burning by PIA.
- Dedicated person working for the PIA to do daily pickups of all household rubbish containers and centralise rubbish in PIA sealed containers, wash and clean sealed buckets to interchange with collected household buckets. Also to manage contained burning.
- Small boat and skipper to run daily trips outside the reef to dispose of used coconut husks and food waste.
- Timeframe:** The management system should be in place by mid June at the latest in order for the community to adapt behaviours to the new system, and to identify and solve any issues well before baiting begins. The management of household rubbish should stay in place for at least one month post the final bait application.
- Responsibility:** System created and administered by the PIA. Sanctioned by the Island Council, households responsible for the management of their own

### 3.2.9 Monitoring to confirm pre-eradication absence of rats on rat free motu

- Issue:** Home Island and Cooks motu are the only motu on the Atoll where rats are present, based on anecdote, intensive detection effort in November 2022, and coconut crab surveys done in 2018. There is a unlikely but small risk rats could establish on other islands between last rodent detection efforts took place and the eradication.
- Action:** In the month prior to bait being applied, baited trail cameras will be established on Karakarake, North, Primrose, and Toms motu in order to ensure rats have not established on these motu.
- Cameras will be set to record 10 second video clips, and 5 cameras will be established for a week at each motu, before footage is downloaded and reviewed. Baiting will consist of motolures with high oleic content peanut butter, with dispensing mode set to 2.0ml one hour after sunset. Motolures, SD cards, batteries, and cameras are already present on Palmerston.
- Julianna Marsters** (PIA) will establish the 5 cameras and motolures on each motu, before collecting and moving them onto each sequential motu. SD cards will be stored and reviewed by **Jenny Long** when the track/grid team deploys on Palmerston.

<b>Resources:</b>	5 cameras, batteries, SD cards, motolures with high oleic content peanut butter have been left with the PIA on Palmerston.
<b>Timeframe:</b>	Data should be collected and reviewed prior to the arrival of the baiting team. Ideally cameras would be setup on the first motu by mid June and rotated through the month, so data is ready to review in June.
<b>Responsibility:</b>	PIA to setup cameras with instructions/assistance from project manager, and data to be reviewed by DOC staff.

### 3.2.10 Clear biosecurity rules and processes in place for receiving passengers and goods from outside the Atoll

<b>Issue:</b>	For the eradication to be successful, the community must have the ability to prevent the invasion and re-establishment of rodent species. Clear biosecurity procedures relating to incoming freight and passengers to the Atoll need to be in place and engaged and agreed upon by the community.
<b>Action:</b>	Biosecurity review being run by Pete Corson on behalf of MOA identifies recommended procedures for the Island Council and EO to instigate for the Atoll.
<b>Resources:</b>	Project to fund contractor Pete Corson to do biosecurity review, and resources required for procedures can be acquired with assistance of the project.
<b>Timeframe:</b>	Recommendations to be provided by Pete Corson by the end of April, with Palmerston to instigate prior to grid team arriving in July/August. Biosecurity surveillance infrastructure will be installed with the help of the field team in August.
<b>Responsibility:</b>	MOA and Pete Corson to provide recommendations, EO and Island Council to consider and instigate, and project manager to assist in providing identified resources required.

## 3.3 Phase 1: Grid construction (July 2023)

Phase 1 consists of a field team travelling from Rarotonga to Palmerston, and leading the creation of a 20 by 20 metre grid across the operation blocks (Home Island and Cooks motu) with assistance from 3-4 persons from the Palmerston community. Transport of the team between Rarotonga and the atoll will also include 6 tonne of toxic bait for use in phase 2, and field equipment and food required for both phases 1 and 2. Phase 1 will also allow for the monitoring of community preparation actions as outlined in the previous section, and if needed the field team can resource additional help needed to resolve issues. Phase 1 is expected to take 14-18 days on the Atoll.

### 3.3.1 Field team

The field team consisting of ten staff, eight of which will travel from Rarotonga/NZ. Each of the experienced field team staff will pair with a member of the Palmerston community or new Rarotongan staff to create 3-4 teams to carry out work to create the 20x20m grids within the operation blocks. The team lead will assist with this work but their main focus will be ensuring quality control and accuracy of the grid across the teams.

### 3.3.2 Transport of bait, field gear, and food

The vessel delivering the Phase 1 field team will also transport 6 tonnes of Pestoff 20R rodent bait, packaged in sealed plastic 10kg poly-pails. Effort should be made to reduce handling of bait to prevent fragmentation of bait, and to reduce extreme temperature changes if possible (ie keep out of direct sunlight, keep off ground via pallets, and stored in areas with good air circulation when possible). The majority of field gear for phases 1 and 2 will be transported on the phase 1 vessel also.

When arriving on Palmerston, priority should be to transport bait to the designated storage area (Reverand Tere Marsters house). Bait should be stored on pallets on the concrete pad under the shaded area of the building.

The grid field team will establish residence and a working area in the Emergency Management Center on Palmerston on arrival. Field gear should be sorted with a clear storage system, and IT and charging systems setup. One room should be allocated for meetings/working area – away from the communal space where work and sleeping also occurs. Any known snorers should be identified and a separate sleeping area created for them to reduce disturbance of sleep to the rest of the team throughout the fieldwork period.

### 3.3.3 Meeting and briefing of the community

Building relationships with each individual in the community, and the community fully understanding the tasks and requirements of the eradication are integral to the eradication succeeding.

A community meeting should be scheduled early in the fieldtrip before any fieldwork begins. At this meeting, the field team should introduce themselves, and present what will happen over the Phase 1 and Phase 2 periods, including – what, who, where, why, and how – clearly identifying the roles of individuals and the need from the community.

On the following day, the field team should plan to spend time visiting each household to become familiar with buildings and sites on Home Island, meet the community on an individual basis and answer any questions they have, and identify any outstanding community management issues that need addressing (as per **section 3.2**).

### 3.3.4 Operation blocks/treatment areas

The eradication consists of five operation blocks, one on Home Island (35.9ha), and four on Cooks motu (28.9ha). The boundaries of the operational blocks are shown in **Figures 3.1-3.3**.



Figure 3.1: Rat eradication operation blocks, Palmerston Atoll



Figure 3.2: Home Island operation block with example 20x20m grid layout

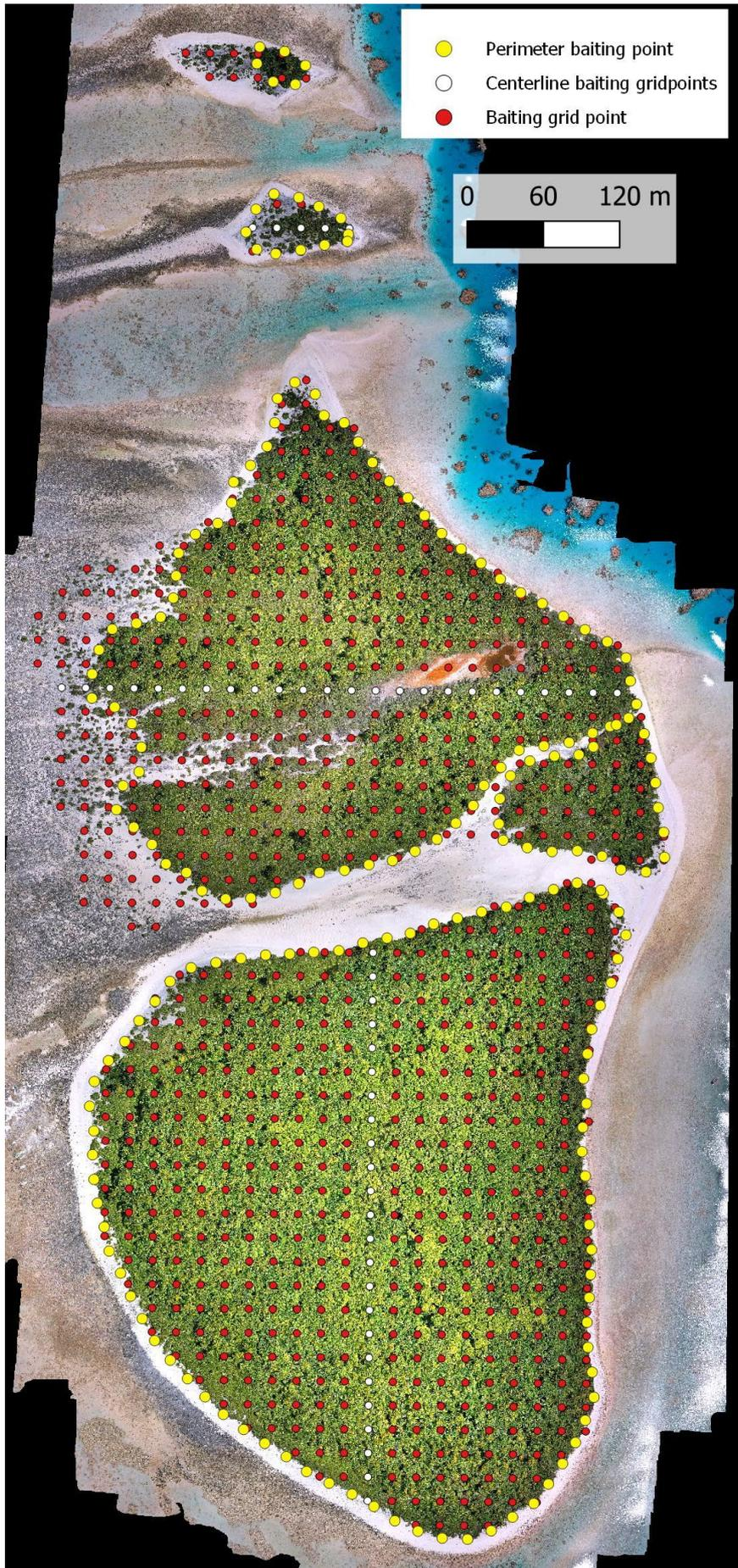

### 3.3.5 Grid creation

A 20 metre by 20 metre marked grid network will be created across the entire treatment area for the purposes of demarcating baiting distribution points during phase 2. Grid layout will first be completed on Home Island, before moving onto Cooks motu.

Initial spatial layouts of the grid will be generated using GIS and projects loaded onto QField – a mobile spatial navigation and spatial data management application. Field teams will use Real Time Kinematic equipment that links with the Qfield app to locate pre-planned points in the field to less than 1 meter accuracy, where the grid point will be physically demarcated using flagging tape on vegetation, or a bamboo pole. Using the RTK gear will involve establish an Emlid Reach RS2 base system in a permanently marked location to act as a base station that will communicate with Reach RS2 rover units used by the field team through a LORA connection.

In the event the RTK equipment is not performing satisfactorily, the backup and redundancy is to use a combination of handheld Garmin GPS units which are equipped with GAILEO satellite access (Garmin 65-67 units) and sighting compasses and 20 meter string lines to construct the grid. In the event this occurs, field teams should use the QField app projects or Garmin 66/67 handheld units for spatial guidance in establishing the grid, but rely ultimately on the bearings of the sighting compasses, stringlines, and backbone transect origin point in determining transect and grid point locations, as this will be more accurate than GPS accuracy will allow.

Transect lines should begin down a ‘backbone’ or centre-line down the middle of the operation block to act as a reference line and ensure correct spacing between transects (see **Figure 3.2** for an example on Home Island). All transects should come off at right angles to this clearly identified central line. It is estimated that it will take 8-10 days total to complete the grids on all operational blocks, with 3 teams of 3.

Laying out of the grid will be done using RTK equipment to locate pre-generated grid points. Team practice of this will occur on Palmerston prior to laying out the grid to ensure all team members are competent and consistent with the methodology; and to ensure the technology works with sufficient accuracy at the field site. Teams of 2-3 people will be used – one person locating the pre-generated point and holding the survey pole with mounted RTK gear and mobile phone app, and will record the data point as field truthed. The other members cut vegetation to this point from the previous point and physically marks the position. The position is marked with a highly visible marker flag or pole. In open spaces, devoid of vegetation – bamboo stakes with flagging attached, or dazzled metal pegs placed in the ground will be used. This will be repeated until entire a transect line and island is covered, working one team per transect. The four grid teams will work side by side on parallel transects to ensure accuracy, and to allow right angle accuracy checks between transects grid points to ensure quality control.

Marking of grid points should be with bright orange or pink flagging tape. The backbone/center line should be marked with blue flagging tape. Transect lines should be cut and marked as such that people can clearly move and see between one grid point to the next. Flagging tape colours should alternate between transects to ensure baiters stay on their designated transect when broadcasting bait. All transect lines should be individually numbered, with a unique identifier clearly written on flagging tape in permanent marker at each baiting point.

At the end of each day when field teams have completed transect establishments – the data champion will download the QField projects from respective team members phones to truth progress and spatial layout of the grid. Once the whole grid has been completed and recorded, this information should be used to check calculations on amount of bait required for each block, and whether the actuality on the island matches the prior desktop planning. GIS checks should look for potential gaps in the layout, which can be checked on the ground.

### 3.3.6 Monitoring of community management issues

One arrival, the field team have the ability to monitor and ensure the identified community management issues identified in section 3.2 have been adequately managed. If outstanding issues are identified early in the field trip, this will provide the ability to potentially aid resourcing any resolutions without impacting the baiting program in phase 2.

### 3.3.7 Establish bait and carcass degradation monitoring sites

Bait and carcass degradation monitoring will be established on Home Island in order to determine when withholding periods for restocking the island with pigs and chickens can be lifted.

Bait and carcass degradation monitoring will consist of 3 x 1m<sup>2</sup> plots caged of with wire mesh (small enough to prevent rodents and hermit crabs entering). One plot should be under forest canopy, one should be in an agricultural area, and one should be in an open area.

Degradation plots will be established by the [Jenny Long](#) in conjunction with [Julianna Marsters](#) (PIA), who will carry out and record the fortnightly measures.

Each plot should contain 2 rat carcasses (caught with traps before baiting begin), and 5 baits. Plots should be clearly labelled, location stored spatially, and have clearly labelled baseline photographs taken of bait and carcasses within the plot from the initial setup. Photos and spatial locations should be recorded and stored in a systematic and clearly named folder structure administered by the data champion. Pictures and descriptions of bait will be recorded on each check, and rainfall and average temperatures for the period recorded by the Palmerston AWS.

### 3.4 Phase 2: Baiting (August 2023)

Phase 2 consists of the field team baiting of the operational blocks. Baiting will consist of two hand broadcast applications of PestOff 20R spaced at least 10 days apart, at prescribed rates (Home Island at 22.3kg per ha, Cooks Motu at 35 kg per ha) across the established 20 x 20 metre baiting grid created in phase 1. Perimeter baiting, special baiting, and baiting buildings will also take place with each of the bait applications.

Bait availability monitoring will also be conducted to determine bait availability over a four-night period post each bait application, in order to make application rate adjustments to the second bait application if needed.

#### 3.4.1 Pre-baiting tasks

##### Meeting and briefing the community

As per 3.3.4, the phase 2 field team will hold a community meeting to brief the community on operations being conducted in this period prior to any fieldwork beginning.

New field team members will be introduced, and discuss the operations of the baiting phase, and identify individuals' roles, and what individual households are required to do.

On the following day, the new field team members will spend time visiting each household to become familiar with buildings and sites on Home Island, meet the community on an individual basis and answer any questions they have, and ensure the quality of community management on identified issues. This can be done in conjunction with the planning for building baiting.

##### Survey of buildings for baiting plan

The building and special baiting team will survey all buildings and sites identified for special baiting with the relevant owner/occupier, and construct physical maps with sites identified, and baiting plans for that site. A spatial database will be constructed on QGIS and linked to a QField with data fields to allow the recording of bait availability at individual bait trays at a site on a given monitoring round. This is the responsibility of the building baiting lead.

An initial survey of most buildings was conducted during the feasibility study. During this period, high resolution drone imagery was recorded and buildings have been mapped and identified on it. This information is available as a spatial database in QGIS, located on the project Onedrive [here](#). A map of the aerial imagery showing buildings on Home Island can be found in Appendix 1, and a spreadsheet compiled identifying all residential houses, their occupants, and baiting trays needed – as well as many of the infrastructure related buildings, can be found in [this spreadsheet](#) in the project Onedrive.

Physical maps should be produced identifying buildings and sites of bait trays within buildings, as well as special baiting areas. Bait trays should be labelled with unique ID that allows the identification of site and bait tray for monitoring purposes.

##### Transect and building allocation and bucket caching

The Project Manager, Grid baiting lead, and Building and Special baiting lead will together delegate baiting transects, buildings, and special baiting areas prior to each bait application.

The baiting grid will be prepared with bait in sealed buckets placed/cached along transect lines so baiters have a continuous supply. On Home Island one bucket will cover 12.5 grid points, while on Cooks motu one bucket will cover 8.3 grid points. Bait caches should be planned by the Grid baiting lead, and the plan delivered by the team so that bait caches are established in the operation block the day before application on that block.

### 3.4.2 Baiting

#### Baiting regime

- All operation blocks will have two hand broadcast applications of bait, with each application within a preferred interval of 10 days apart.
- A forecast of at least 3 nights (72 hours) without significant rain should be sought before an application of bait
- Each hand broadcast application of bait will consist of competing baiting on the 20 x 20m baiting grid within an operation block, and an additional bait application at 20m intervals around the operation block perimeter. The perimeter baiting points will not be physically marked, but generated on a GPS, and baited by a single team member with good handheld GPS skills.
- Each baiter will report to the lead baiter on how many grid points have been sown, with how much bait remaining after using their first bucket of bait. No further baiting is to commence until the grid baiting lead confirms the amount and that the baiter should proceed.
- Each broadcast application on Home Island (operation block 1) will be completed in a day, followed by building baiting and special baiting the following day.
- Each broadcast application on Cooks motu (operation blocks 2,3,4, and 5) will all be completed on the same day.
- The first operation block for baiting will be Home Island, with the first application on Cooks motu operation blocks occurring the day following building baiting being completed on Home Island.

#### Bait type and application rates

PestOff 20R bait is the specific bait product being used. PestOff 20R is a 2 gram cereal bait containing 0.002% of the 2<sup>nd</sup> generation anticoagulant brodifacoum. Bait will be packed in 600 x 10kg poly-pails. A total of six tonne of PestOff 20R has been ordered, allowing for 2180kg for the first application, 2180kg for a second application, and a remaining 1640kg for contingency purposes (increasing the application rate for the second application if needed on any operation blocks). **Table 3.4** outlines prescribed application rates for each operation blocks (**Figures 3.1-3.4**), as well as further baiting details.

**Table 3.4:** Operation block descriptions and bait application rates

Operation block number	1	2	3	4	5
Operation block name	Home Island	Dicky boy North	Dicky boy South	Calcutta	Aparanuta
Application rate	22.3 kg/ ha	35 kg/ ha	35 kg/ ha	35 kg/ ha	35 kg/ ha
Size (ha)	36	0.29	0.31	13.84	17.4
Number of baiting points	1004	10	10	371	450
Bait distributed at each grid point per broadcast application	800g (5 x 160g)	1200g (5 x 240g)	1200g (5 x 240g)	1200g (5 x 240g)	1200g (5 x 240g)
Additional perimeter baiting points	116	6	12	90	79
Total bait required per broadcast application	906kg	18.75kg	26.25kg	563.43kg	659.98kg
Approximate number of buildings requiring bait trays	103	0	0	0	0
Other special baiting requirements	Rubbish pits, long drops, domestic gardens	N/ A	N/ A	N/ A	N/ A

Measurements to achieve bait application rates will be through using pre-measured and cut commercial plastic scoops. There is a specific sized scoop for Home Island, and for Cooks motu – given they have different bait application rates.

## Bait application

### *Broadcast application*

Two hand broadcast applications of bait will be made on each operation block, with a minimum spacing of ten days between applications.

The broadcast baiting team will consist of 5 people and baiting points/transects will be delegated by the **Baiting lead**. It is expected that a bait application of Home Island will be completed in two days (first day completing hand broadcast of grid points, hand broadcast of perimeter, and special baiting hand broadcast; second day building baiting). Cooks motu (operation blocks 2-5) can be completed together in a single day. From each baiting point, bait will be hand broadcast equally (using pre-fabricated scoops) in 5 directions as per **Figure 3.4**. Baiters will be delegated transects by the grid baiting lead and should systematically work adjacent to each other and move as a team on parallel transects so that all team members are spreading bait on adjacent transects and working at the same pace and time across the operation block.

When a transect is complete, baiters will radio this into the project manager who will monitor progress and mark off transects and inspect the quality of bait spread.

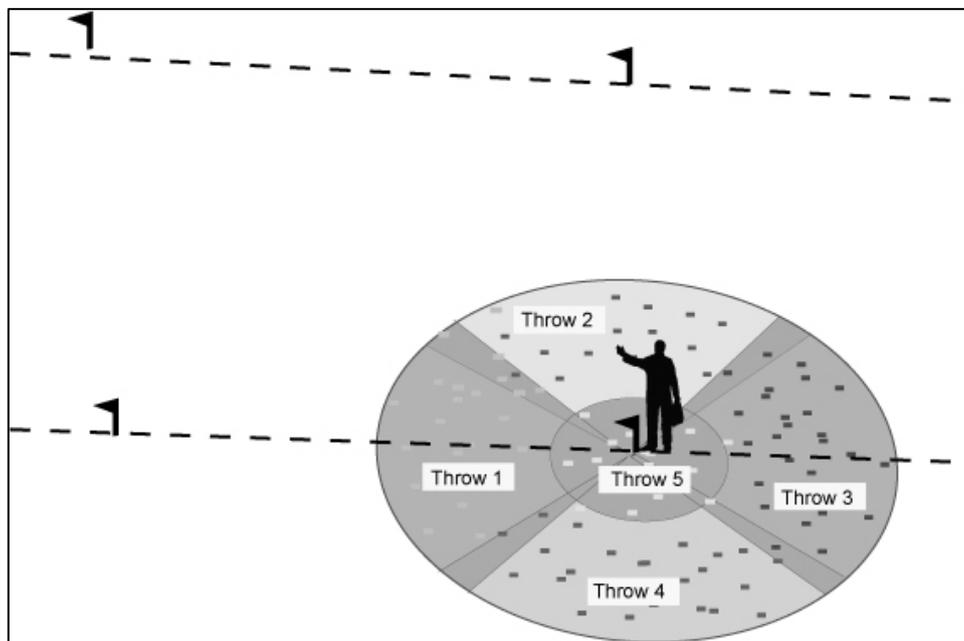

**Figure 3.4:** Baiting technique at baiting points

### *Special area baiting*

Special area baiting will be done concurrently with hand broadcast baiting on grid points. Areas identified for special baiting are confined to Home Island only. They include - rubbish burn holes, long drop toilets, around piles of debris, around piles of coconut husks, and animal pens. These areas will have additional bait broadcast in and around them as they are encountered by baiters completing grid points on their transects.

### *Building baiting*

On Home Island, where buildings and structures are present (approximately 103), at least one cardboard bait tray contain 10 baits will be placed in every room, underfloor, and ceiling space. These bait trays will be monitored daily, with bait disappearance being recorded, and missing baits replaced. When baits have not been consumed for 3 consecutive days, checks will be done weekly until no baits have been eaten for a fortnight.

Bait trays and bait will be placed the day after the first broadcast application, and will be setup initially by a team of 5 people, with buildings to be baited by each individual delegated by the **Building baiting lead**. Bait trays will be checked by a dedicated **building baiter** each day thereafter until weekly checks are required, and this will be handed over to the building owner, or PIA where the building is unoccupied.

### 3.4.3 Bait availability and camera monitoring

#### Bait availability monitoring

Bait availability monitoring will be conducted in each operation block for each bait application for 5 consecutive days starting from the day of each bait application. The monitoring consists of twenty 25m<sup>2</sup> (1m x 25m) transect plots in each operation block. Plots should be randomly generated in a representative proportion of habitat strata. An initial count of bait in each plot is made, with each bait marked by a marker; and repeat counts of plots are conducted for the next successive four days. The design of the methodology used is based on recommendations in Potts et al. (2015).

Outcomes of this monitoring will determine if bait application rates change for the 2<sup>nd</sup> bait application.

Bait availability plots will be established, marked, and counted by members of the baiting team, led by the **Monitoring team lead**. The work will require two people for blocks 1 (Home Island), and 2 people for blocks 2-5 (Cooks motu) for each day of monitoring, taking approximately 2-4 hours per day total.

#### Camera monitoring

Trail cameras will be established on 5 bait monitoring transects on both Home Island and Cooks motu. These cameras will be established on the day of bait application as part of the establishment of bait monitoring plots. The cameras will be set to motion activated recordings of 10sec short video clips. SD cards will be swapped each day concurrent with bait plot remeasurements. The purpose of this monitoring is to provide qualitative information regarding bait consumers and consumption tail-off.

### 3.4.4 Demobilisation

After the 2<sup>nd</sup> bait broadcast application has been completed – flagging tape marking baiting points and any non-natural marking items (such as pegs) should be removed by the field team. Markers used for reference for bait availability plots that are still being measured should be left in place until day five of the bait availability plot measures have been completed. The flagging tape used by the project will be biodegradable and should be able to be burnt on island.

Leftover equipment, excess bait, and any non-burnable rubbish generated by the project will be packaged up and freighted off with the field team; or a scheduled (and paid for) barge pickup at a later date, with arrangements made on the Rarotonga side for receiving and dealing with any freight. Field equipment should be cleaned and dried before packing into sealed fishbins at the EMC, so it can be transported and freighted from Rarotonga back to NZ in conditions acceptable to border biosecurity.

## 3.5 Post-operation monitoring

### 3.5.1 Building bait tray monitoring

After demobilisation and the field team leaving, the Palmerston community will need to continue the monitoring and resupply of bait (if needed) in bait trays located in buildings. Each bait tray must be checked each day until no bait has been consumed or removed for 3 consecutive days, then monitoring of trays moves from daily to weekly.

After two weeks of no bait consumption, bait trays are checked fortnightly until three months post the first bait application period. After this, bait trays can be removed. Records of bait tray checks must be continued and should be administered by the Palmerston Island Administration, and sent to the project manager on completion. Ten 10kg bucket of PestOff 20R bait will be left with the PIA for purposes of refilling bait trays, and potentially reacting to a confined detection after the field team have left if needed.

Remaining bait from bait trays should be disposed as per label requirements: either buried deep and covered, or burnt hot in an area where wind drift will not spread smoke near any residential area or people. When disposing of bait, ensure the bait is not accessible to insects or animals for consumption to avoid the risk of tertiary or secondary poisoning.

### **3.5.2 Bait and carcass monitoring**

The monitoring of the three bait and carcass monitoring plots on Home Island should be done monthly by a PIA staff and recorded and sent to the project manager. Monitoring should include clear photographs and labels of each plot, with a description of the breakdown of baits and carcasses.

When complete breakdown of both carcass and baits has occurred, the project manager will inform PIA that bait and carcass plots can be disestablished.

### **3.5.3 Post-operation success monitoring**

Post-operation monitoring to validate the eradication outcome is proposed to take place in February/March 2024, at least 6 months post bait application. Given this period is approximately 6 months after the proposed bait application period, the area is small and productive, it is quite likely that residents of Palmerston would detect any residual rats within that time period if the eradication was unsuccessful on Home Island. However, if rats have not been observed by February 2024 by the community, a series of baited trial cameras will be established on Home Island and Cooks motu over a week period, and footage will be reviewed to determine if the eradication was successful.

Post operation success monitoring will be carried out by staff from the PIA with remote support and data processing/writeup from DOC.

### **3.5.4 Social outcome monitoring**

The eradication of rats from Palmerston Atoll is anticipated to bring significant livelihood benefits. A qualitative group survey will be conducted with the community, Island Council, and PIA during the post-operation success monitoring. Accounts of agricultural yields in comparison with when rats were present will also be used.

Social outcome monitoring will be carried out by the PIA with support from the Project Manager (DOC).

## Section 4: Logistic details

### 4.1 Bait production, transport, and storage

Six tonnes of PestOff 20R will be produced by Orillion at their Wanganui factory (contact John Quigley). Bait is being manufactured in late April 2023. Bait will be stored in sealed plastic poly-pails in the factory until it is freighted to Auckland.

Bait transport between Whanganui and Auckland will be organised by Orillion and delivered by Mainfreight. The consignment will use ISPM 15 export pallets of 1.1m x 1.1m. 8 pallets will have 3 layers of 16 pails or 48 pails per pallet, with a cube metric of 1.45m<sup>3</sup> per pallet. 6 pallets will have 32 pails (2 layers) and one pallet will have 24 pails (2 layers – but on 8 on second layer). Cube metrics of these 7 pallets is approximately 1.03m<sup>3</sup> each. All pallets will have shrinkwrap around the sides.

Mainfreight will deliver this consignment to Sea Shuttle Express Ltd at 70 Ascot Road Auckland (contact Wayne Carroll) early in the week of 22 May. Sea Containers NZ (contact Odin Madsen) will deliver a pre-purchased prepared insulated container (internal dimensions 2280mm wide, 5400mm long, 2230mm high) to the Sea Shuttle Express yard on the 15<sup>th</sup> May. The bait consignment will be loaded into this container via forklift when it arrives at the Sea Shuttle Express yard, with the ground floor being loaded with the 8 x 3 layer pallets, and the 7 smaller pallets being loaded on top. There will be room for an additional pallet of field gear, as well as an additional 1m of usable length space for fishbins. Orillion will provide 8 x container silica sticks for the container which will be fitted by Sea Shuttle Express on the internal container hooks after taking off the plastic wrap. The container will not be loaded in wet weather, and Shuttle Express will do a biosecurity check of the container for insects prior to pallets being loaded, and bait will be stored in cool dry storage out of direct or diffused sunlight prior to being loaded into the container.

Sea Shuttle Express will organise the shipping of the container through to clearance at the Rarotonga end. The consignment will be on Liloa II (voyage #77) with an ETD Auckland on 8/6/23 and an ETA at Rarotonga on 23/6/23. Custom clearing agents are Transam Ltd on the Rarotonga end, with clearance expected to take less than five days after the arrival of Liloa II. The Ministry of Agriculture has liaised with customs and the clearing agent to organise exemption of customs charges to the field gear due to being loan or donation equipment for the project.

The toxic bait will be immediately cleared from customs and put onboard the Lady Moana and shipped to Palmerston in late June, where it will be received by the community and unloaded and transported to an outside secure shaded site, sheltered from weather, where it will be stacked on pallets. The storage site is a shaded area on a concrete pad with good air ventilation, under the 2<sup>nd</sup> storey of an unoccupied residential building. The bait storage is approximately 280m via a formed road from the mid-point of the centre island baiting transect, located next to the accommodation where the field-team will be based.

A tractor and trailer unit, as well as a quad bike and trailer will be available to assist with transportation of bait buckets around Home Island. Small boats (based on Home Island) will assist the delivery of bait to Cooks motu (operation blocks 2-5).

The container with remaining field gear will be moved from Port by Cook Islands General Transport to a site in Matavera, Rarotonga. The container will be placed on level ground, with a hard surface that will allow a vehicle to deliver and retrieve the container without issue.

Prior to the day of departure for Palmerston Atoll on the Anuanua Moana on the 4/8/23, field gear and equipment from the pallet will be moved using a hire vehicle and the TIS flat deck truck to the Port. Gear will be loaded as per instructions of the vessel's skipper.

Unloading of the bait from the Anuanua Moana to Palmerston will involve the manual handling of gear from the Anuanua to the PIA barge or small boats. It is likely to take 4-5 small boat/barge loads to ferry all field gear, staff, and bait to Home Island from the Anuanua. On Home Island, the bait buckets will be unloaded individually onto a

flat deck trailer pulled by the Island tractor. The tractor will deliver the bait to the allocated bait storage site, where bait will be stored on pallets as they were originally packed, on a concrete pad and in full shade.

The day before a bait broadcast application occurs in an operation block, bait pails will be cached along the planned baiting routes so that baiters do not have to leave their baiting transect routes to travel back to a central bait repository. A bait caching plan will be made and delegated by the **Baiting team lead** after the finalisation of the baiting grid on the ground. Caching bait ensures baiters will not need to carry anymore than one 10kg pail at any one time when baiting the grid. Empty plastic pails and lids will be collected by baiters and left at the end of transects or the center line, to be staff delegated by the **Baiting team lead**.

Approximately 1.6 tonne of bait is contingency bait that may not be used if bait availability monitoring shows increasing baiting rates or a third application are not required. Remaining bait in sealed pails will be transported back to Rarotonga on the next cargo vessel visiting Palmerston (likely the Taunganui barge) to load and return the bait to Rarotonga from Palmerston. From Rarotonga, Te Ipukarea Society will take ownership of the bait for the use in the Takitimu Conservation Area, where brodifacoum is currently being used to control rodents on cyclic basis.

## 4.2 Field gear

The majority of field gear required for field operations will be shipped by sea freight with the bait consignment in the insulated container. This will be sent from Invercargill to the Sea shuttle express yard, and will follow the same transport and storage pathway as the bait. Once at Palmerston Atoll, it will be stored at the EMC where field staff are accommodated.

A small amount of field gear will come as carry on luggage with staff from New Zealand, and stored and transported with personal gear between NZ and Palmerston Atoll.

Field equipment, transport, and consignment storage is identified in the [project planning sheet here](#).

## 4.3 International travel between Rarotonga from New Zealand

Staff from New Zealand will fly to and from Auckland from their home destination and will require to stay overnight in a hotel before boarding an international flight to Rarotonga the next morning.

Flight and accommodation details are provided in the [project planning sheet](#)

## 4.4 Accommodation in Rarotonga

Staff from New Zealand will stay at accommodation in Rarotonga prior to departing on the Anuanua for Palmerston Atoll. The fieldteam will have two days in Rarotonga prior to departing in order to check over gear, oversea the loading of the Anuanua, and for team preparation and briefing.

A hired car will be available for staff during time in Rarotonga to assist with logistics and travel.

Accommodation arrangements for Rarotonga and rental car details are provided in the [project planning sheet](#).

## 4.5 Transport between Rarotonga and Palmerston Atoll

Transport vessels between Rarotonga and Palmerston Atoll for the field delivery period are identified in **Table 4.1**.

**Table 4.1:** Vessel logistics between Rarotonga and Palmerston Atoll

Departing (CI time)	Arriving (CI time)	Back in Port	Vessel	Cargo	Notes
Rarotonga 28/6	Palmerston 30/6	?	Lady Moana	6 tonne of toxic bait in 600 x 10kg poly pails	Vessel travelling to Northern Pa Enuā and heading to Palmerston on a chartered deviation
Rarotonga 5/8 (TBC)	Palmerston 6/8	?	Anuanua Moana	8 pax, personal gear, and field gear	Vessel on course for licensed exploration area, chartering small deviation to Palmerston. Plenty of room for cargo and passengers
Palmerston mid September, TBC	Rarotonga 3-5 days post departing Palmerston	?	Marumarū Atua	8 pax, personal gear, and field gear	Return journey - will communicate with CIVS around progress of field work and exact pickup date will be determined by this and weather conditions,

#### 4.6 Purchase of food supplies for Palmerston Atoll

Food preparation for the field team whilst on Palmerston will be prepared by the community (paid for by the project). The community will identify what food will be required to be shipped to Palmerston on a prior scheduled barge trip. The PIA will identify items required to TIS, who will arrange the purchase and delivery of items to Palmerston and invoice DOC for reimbursement.

#### 4.7 Accommodation on Palmerston Atoll

The field team from Rarotonga and New Zealand will be accommodated in the Emergency Management Center on Home Island. Field gear should be sorted with a clear storage system, and IT and charging systems setup. One room should be allocated for meetings/working area - away from the communal space where work and sleeping also occurs. Any known snorers should be identified and a separate sleeping area created for them to reduce disturbance of sleep to the rest of the team throughout the fieldwork period.

The project will pay per person per night for accommodation, along with food, for use of the EMC. This will be paid by TIS and invoiced and reimbursed by DOC.

#### 4.8 Communications

Communication in the field between team members will be done via VHF radio on a dedicated marine channel (marine 67 unless stated otherwise). VHF coverage is good within islands but is broken between Cooks motu and Home Island unless standing on adjacent coasts. Communication between islands will be between team leaders using inReach messaging.

Starlink internet will be established at the EMC, and the Palmerston Island Administration wifi via Vodafone satellite will be used as a backup if Starlink does not function on Palmerston.

## Section 5: Health and Safety

Key health and safety information can be found in the Health and Safety and Emergency procedures document [DOC-7391155](#) or [here](#).

Jenny Long (Safety Officer) will lead Job Safety Analyses with the team for new activities, or when conditions/factors for these activities change. Partner organisations, and the Palmerston Island Administration will be asked to identify any hazards, mitigation methods, and PPE required to undertake these activities – prior to the field teams deploying. Partner organisations will be offered to work under DOCs H&S procedures, or their own organisations’.

Health and Safety procedures for the delivery phase of the project should be well suited to context given they are based on similar activities, locations, and logistics.

## Section 6: Workplan, task specifications, and equipment list

### 6.1 Workplan of field delivery

Day #	Date (Cook Islands)	Day (Cook Islands)							
1	1/08/2023	Tuesday							
2	2/08/2023	Wednesday	NZ team fly to Auckland (4)						
3	3/08/2023	Thursday	NZ team travel to Rarotonga, meet with other team members for briefing (8)						
4	4/08/2023	Friday	Biosecurity of personal and field gear transport to and load vessel, vessel briefing (8)						
5	5/08/2023	Saturday							
6	6/08/2023	Sunday							
7	7/08/2023	Monday	Travel to Palmerston on the Anuanua Moana (8)						
8	8/08/2023	Tuesday	Arrive Palmerston, unload gear, welcome and setup (8)						
9	9/08/2023	Wednesday	Community meeting/briefing/Q&A (8)	Building baiting plan (2)	Face to face meeting with households (8)	Community issues monitoring (8)			
10	10/08/2023	Thursday	Practice with RTK gear and grid layout (8)						
11	11/08/2023	Friday	Home Island grid construction (10)						
12	12/08/2023	Saturday							
13	13/08/2023	Sunday	Home Island grid construction (10)						
14	14/08/2023	Monday							
15	15/08/2023	Tuesday	Home Island grid construction (10)						
16	16/08/2023	Wednesday							
17	17/08/2023	Thursday	Cooks motu grid layout (10)						
18	18/08/2023	Friday							
19	19/08/2023	Saturday	Cooks motu grid layout (10)						
20	20/08/2023	Sunday							
21	21/08/2023	Monday	Cooks motu grid layout (10)						
22	22/08/2023	Tuesday							
23	23/08/2023	Wednesday	Comm. Issues resourcing (?)	Setting up building baiting trays (2)	Ensuring data recording systems are ready (1)	Catch and freeze rats for degradation (2)	Setup bait availability plots? (4)		
24	24/08/2023	Thursday	Rest and data catchup, gear prep	Home bait availability plots (3)	Bait caching on Cooks (4)	Data collection and validation		Bait caching on Home (4)	
25	25/08/2023	Friday	Grid and perimeter baiting of Home (7)						
26	26/08/2023	Saturday	Building baiting (Home) (3)	Cooks bait availability plots (3)					
27	27/08/2023	Sunday							
28	28/08/2023	Monday	Grid and perimeter baiting of Cooks (7)	Home bait availability plots (3)					
29	29/08/2023	Tuesday	Bucket cleanup (Cooks & Home) (7)						
30	30/08/2023	Wednesday	Building baiting (Home) (3)	Biosecurity infrastructure setup (7)					
31	31/08/2023	Thursday							
32	1/09/2023	Friday		Biosecurity infrastructure setup (7)					
33	2/09/2023	Saturday	Building baiting (Home) (3)						
34	3/09/2023	Sunday		Home bait availability plots (3)	Bait caching on Cooks (4)				
35	4/09/2023	Monday							
36	5/09/2023	Tuesday	Bait caching (Home)	Home bait availability plots (3)					
37	6/09/2023	Wednesday	Grid and perimeter baiting of Home (7)						
38	7/09/2023	Thursday	Building baiting (Home) (3)	Cooks bait availability plots (3)					
39	8/09/2023	Friday	Grid and perimeter baiting of Cooks (7)						
40	9/09/2023	Saturday	Bucket cleanup (Cooks & Home) (7)						
41	10/09/2023	Sunday							
42	11/09/2023	Monday	Building baiting (Home) (3)						
43	12/09/2023	Tuesday							
44	13/09/2023	Wednesday							
45	14/09/2023	Thursday	Building baiting (Home) (3)						
46	15/09/2023	Friday							
47	16/09/2023	Saturday							
48	17/09/2023	Sunday	Vaka pickup and travel to Rarotonga (8)						
	18/09/2023	Monday							
	19/09/2023	Tuesday							
	20/09/2023	Wednesday	Arrive Rarotonga (8)						
	21/09/2023	Thursday	Depart to NZ (4)						

## 6.2 Task specification document links

Please see the [Palmerston Atoll eradication planning sheet](#) document register for all task specification links.

Task specifications include:

Field team food purchase and consignment for palmerston
Bait transport to storage site in Rarotonga, and management of bait in storage
Loading of bait onto TKII and off TKII
Grid layout lead
Grid layout team member
Baiting lead
Grid baiting
Perimeter baiting
Bait caching and baiting preparation
Building baiting lead
Building baiter
Follow-up building baiter and monitoring
Monitoring lead
Bait availability plot establishment
Bait availability remeasurement
Bait plot camera monitoring
Bait and carcass plot establishment
Bait and carcass monitoring
Monitoring progress of community management issues
Pre-operation surveillance on outer motu
Demobilisation
Removal of bait trays
Data champion

## 6.3 Equipment list

Equipment and freight list can be found in the 'equipment' tab of the planning sheet, [linked here](#).

# Appendix 1: Building locations on Home Island

